

# Introduction to the tokamak GOLEM operation Practical guide

Vojtěch Svoboda  
on behalf of the tokamak GOLEM team  
for FJFI CVUT - UPP

March 11, 2025

# Table of Contents

- 1 Introduction
- 2 The Tokamak (GOLEM)
- 3 The Tokamak GOLEM (remote) operation
- 4 Conclusion
- 5 Appendix

# Milestones to Fusion Power Plant

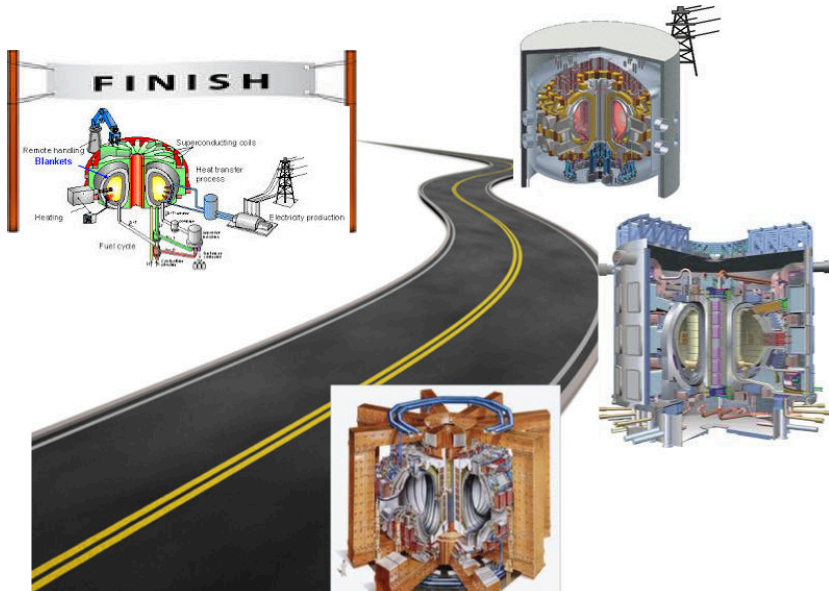

# Education importance



Let's start with the tokamak GOLEM - *the smallest tokamak in the World with the biggest control room*

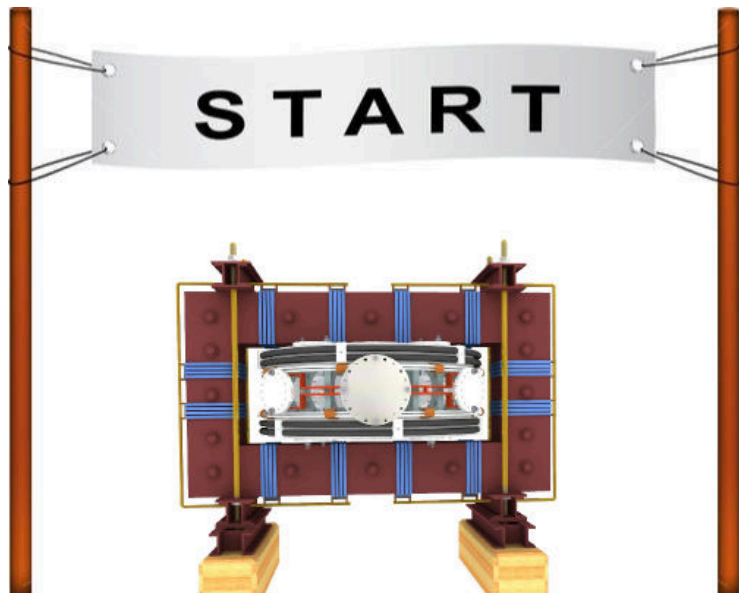

# The GOLEM tokamak basic characteristics

*The grandfather of all tokamaks (ITER newslines 06/18)*

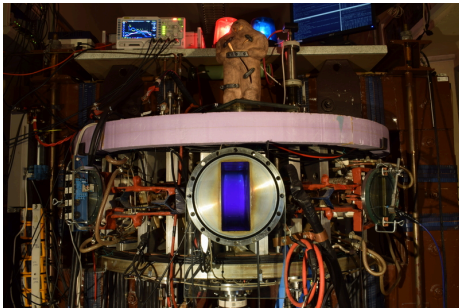

- Vessel major radius:  $R_0 = 0.4$  m
- Vessel minor radius:  $r_0 = 0.1$  m
- Maximum plasma current:  
 $I_p^{\max} < 8$  kA
- Maximum toroidal magnetic field:  $B_t^{\max} < 0.5$  T
- Typical electron density:  
 $\langle n_e \rangle \in (0.2, 3) \cdot 10^{19} \text{ m}^{-3}$
- Maximum electron temperature:  
 $T_e^{\max} < 80$  eV
- Maximum discharge duration:  
 $\tau_p^{\max} < 25$  ms

# Tokamak GOLEM @ Wikipedia ..

File Edit View Go Bookmarks Tools Settings Window Help

W https://en.wikipedia.org/wiki/Tokamak

home Kalendarj Produkce Forecast Slovník Ráno

Not logged in [Talk](#) [Contributions](#) [Create account](#) [Log in](#)

Article [Talk](#) [Read](#) [Edit](#) [View history](#)

 **WIKIPEDIA**  
The Free Encyclopedia

[Main page](#)  
[Contents](#)  
[Featured content](#)  
[Current events](#)

## Tokamak

From Wikipedia, the free encyclopedia

*This article is about the fusion reaction device. For other uses, see [Tokamak \(disambiguation\)](#).*

A **tokamak** (Russian: **токамак**) is a device that uses a powerful magnetic field to confine plasma in the shape of a torus. Achieving a stable plasma equilibrium requires magnetic field lines that wrap around the torus in a helical shape. Such a helical field can be generated by adding a toroidal field

it decays into a proton and electron with the emission of energy. When the time comes to actually try to make electricity from a tokamak-based reactor, some of the neutrons produced in the fusion process would be absorbed by a liquid metal blanket and their kinetic energy would be used in heat-transfer processes to ultimately turn a generator.

### Experimental tokamaks [[edit](#)]

#### Currently in operation [[edit](#)]

(in chronological order of start of operations)

- 1960s: TM1-MH (since 1977 Castor; since 2007 Golem<sup>[12]</sup>) in Prague, Czech Republic. In operation in Kurchatov Institute since early 1960s but renamed to Castor in 1977 and moved to IPP CAS,<sup>[13]</sup> Prague; in 2007 moved to FNSPE, Czech Technical University in Prague and renamed to Golem.<sup>[14]</sup>
- 1975: T-10, in Kurchatov Institute, Moscow, Russia (formerly Soviet Union); 2 MW
- 1983: Joint European Torus (JET), in Culham, United Kingdom
- 1985: JT-60, in Naka, Ibaraki Prefecture, Japan; (Currently undergoing upgrade to Super, Advanced model)
- 1987: STOR-M, University of Saskatchewan; Canada; first demonstration of alternating current in a tokamak.
- 1988: Tore Supra,<sup>[15]</sup> at the CEA, Cadarache, France
- 1989: Aditya, at Institute for Plasma Research (IPR) in Gujarat, India
- 1980s: DIII-D,<sup>[16]</sup> in San Diego, USA; operated by General Atomics since the late 1980s
- 1989: COMPASS,<sup>[13]</sup> in Prague, Czech Republic; in operation since 2008, previously operated from 1989 to 1999 in Culham, United Kingdom
- 1990: FTU, in Frascati, Italy
- 1991: Tokamak ISTTOK,<sup>[17]</sup> at the Instituto de Plasmas e Fusão Nuclear, Lisbon, Portugal;
- 1991: ASDEX Upgrade, in Garching, Germany



Alcator C-Mod



ida, the free encyclo... W Tokamak - Wikipedia, the free encyclo... [svoboda] buon@fi.cvut.cz - Kosside [Krusader] Inbox - svoboda@fi.cvut.cz - Mail

# The GOLEM tokamak for education - historical background

Kurchatov Institute near Moscow,  
Soviet Union  
1960: **TM1-MH**

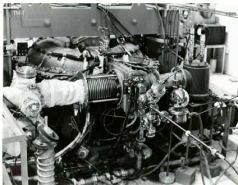

1974

Institute of Plasma Physics  
Czech republic

**CASTOR**

**COMPASS**

2008

Czech Technical University Prague  
Czech republic  
**GOLEM**



Culham Centre for Fusion Energy  
Great Britain  
1989: **COMPASS-D**

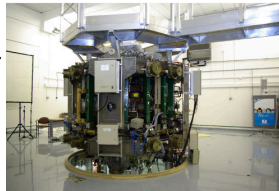

2006





# GOLEM

... somewhere, in the ancient cellars of Prague,

*there is hidden indeed "infernal" power. Yet it is the very power of celestial stars themselves. Calmly dormant, awaiting mankind to discover the magic key, to use this power for their benefit. . .*



At the end of the 16th century, in the times when the Czech lands were ruled by Emperor Rudolf II, in Prague, there were Rabbi Judah Loew, well known alchemist, thinker, scholar, writer and inventor of the legendary GOLEM - a clay creature inspired with the Universe power that pursued his master's command after being brought to life with a shem, . Golem is not perceived as a symbol of evil, but rather as a symbol of power which might be useful but is very challenging to handle. To learn more of the Golem legend, see e.g. [1].

# The global schematic overview of the tokamak GOLEM experiment

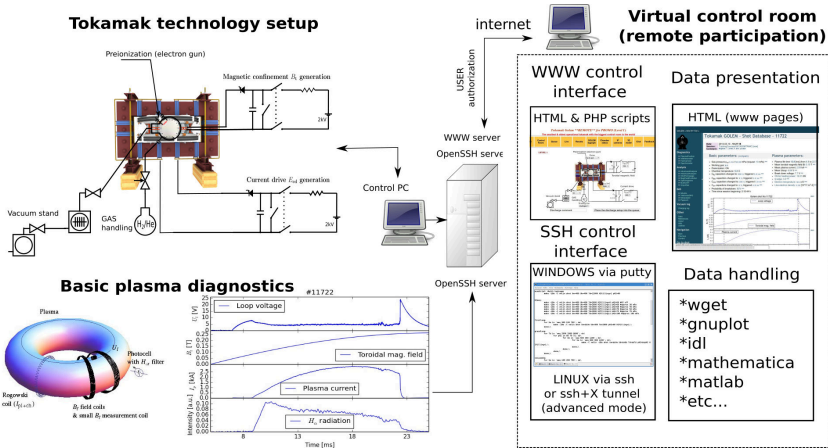

# The GOLEM tokamak mission

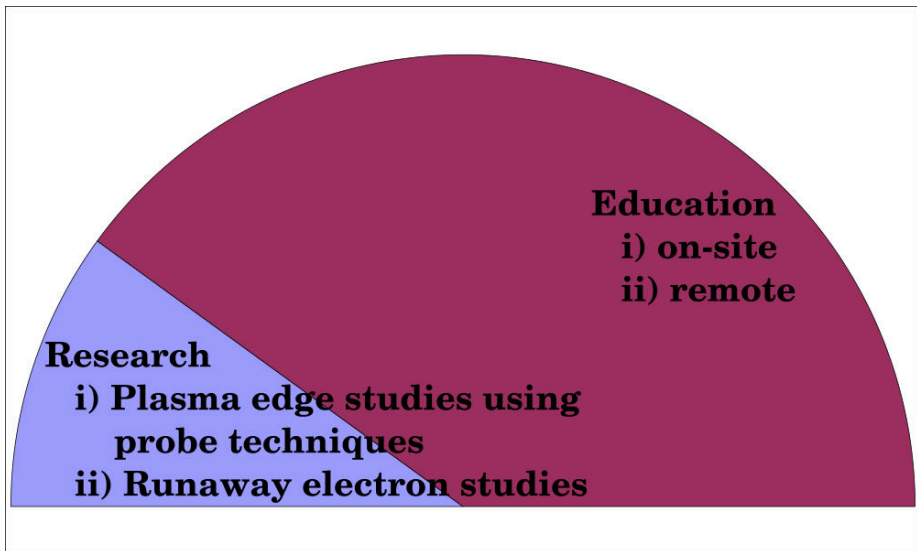

- Everything via `http://golem.fjfi.cvut.cz/UPP`
  - This presentation
  - Control rooms
  - Contact: Vojtech Svoboda,  
+420 737673903,  
vojtech.svoboda@fjfi.cvut.cz
  - Videoconference:  
`https://meet.google.com/hnv-qjhu-xvi`

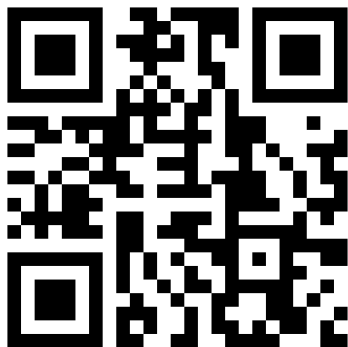

# Table of Contents

- 1 Introduction
- 2 The Tokamak (GOLEM)**
- 3 The Tokamak GOLEM (remote) operation
- 4 Conclusion
- 5 Appendix

# Tokamak magnetic confinement concept

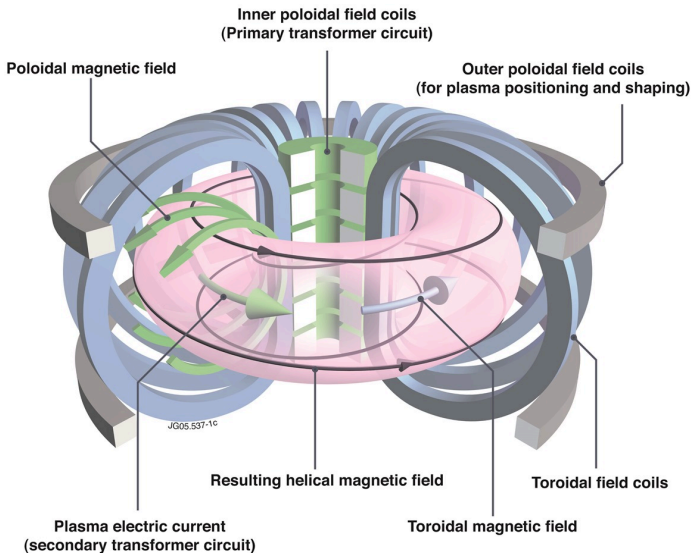

# Tokamak (GOLEM) basic concept to confine and heat the plasma

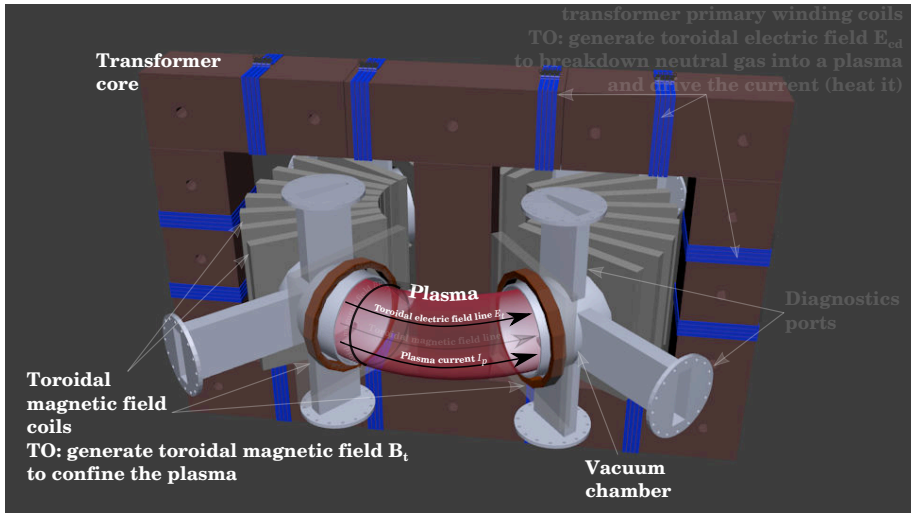

# Table of Contents

## 1 Introduction

## 2 The Tokamak (GOLEM)

- The GOLEM tokamak concept
- The scenario to make the (GOLEM) tokamak discharge
- The scenario to discharge virtually
- The GOLEM tokamak - guide tour
- The GOLEM tokamak basic diagnostics

## 3 The Tokamak GOLEM (remote) operation

## 4 Conclusion

## 5 Appendix



Our goal: the technology to create a  $\mu$ Sun on the Earth

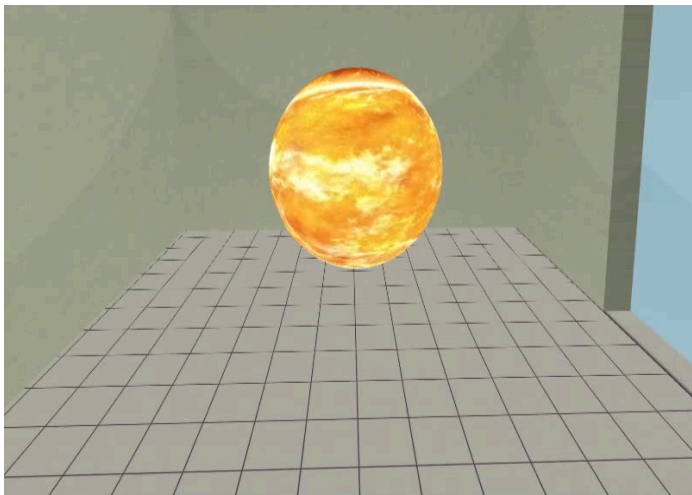

# Magnetic confinement requires toroidal geometry

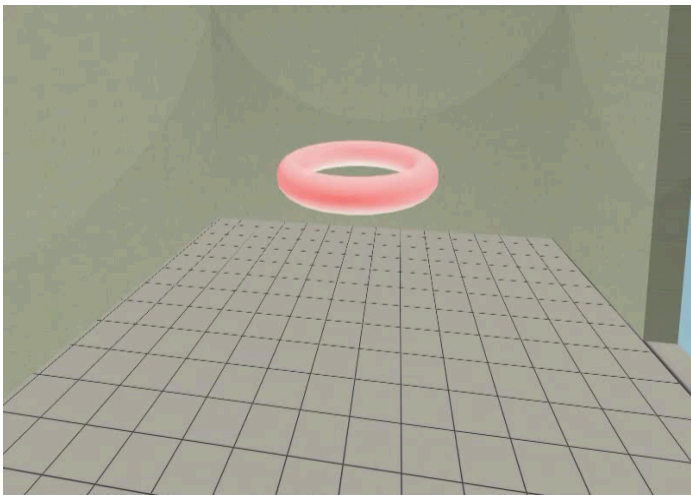

A chamber contains the thermonuclear reaction

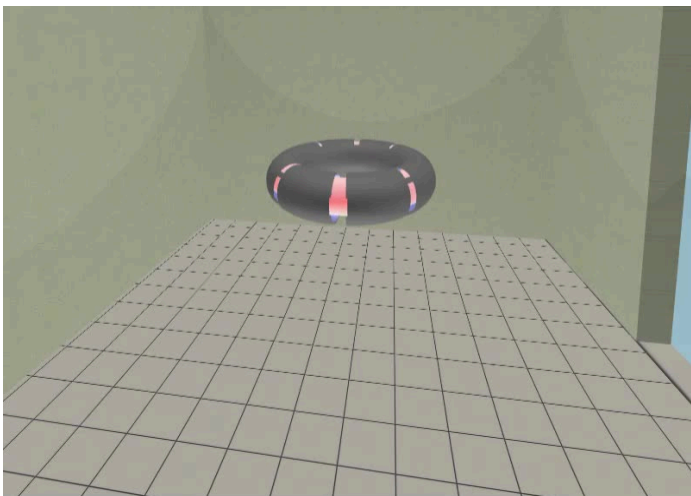

Toroidal magnetic field coils confine the plasma

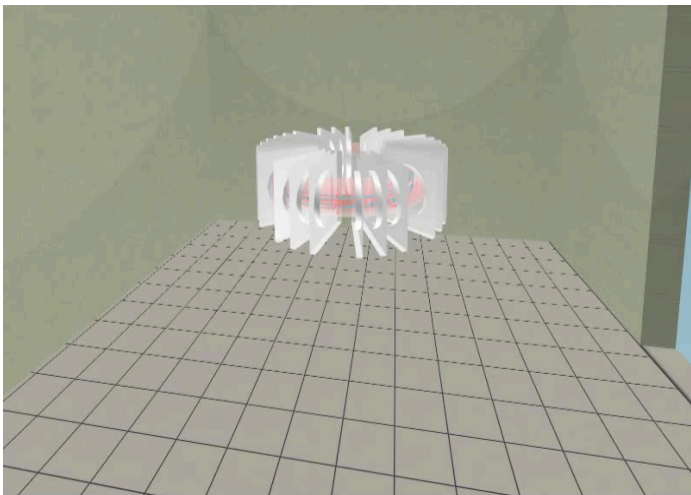

A transformer action creates and heats the plasma

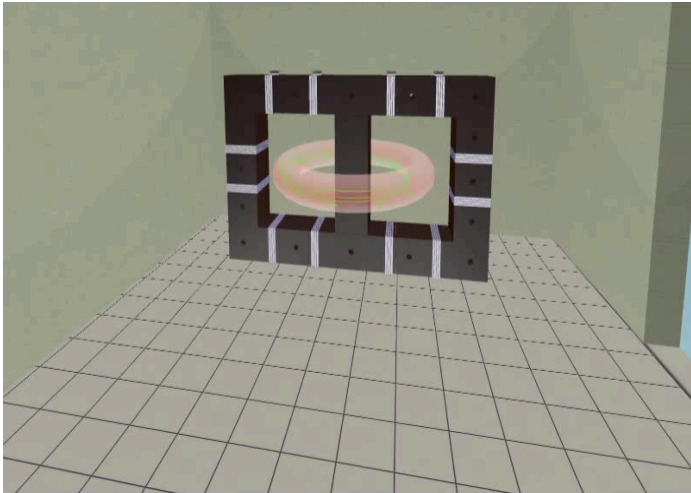

# The final technology altogether

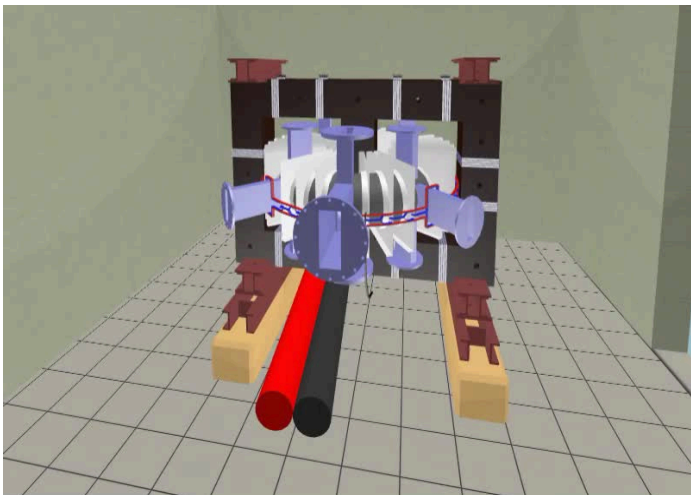

# Table of Contents

## 1 Introduction

## 2 The Tokamak (GOLEM)

- The GOLEM tokamak concept
- The scenario to make the (GOLEM) tokamak discharge
- The scenario to discharge virtually
- The GOLEM tokamak - guide tour
- The GOLEM tokamak basic diagnostics

## 3 The Tokamak GOLEM (remote) operation

## 4 Conclusion

## 5 Appendix

# Plasma in Tokamak (GOLEM) - the least to do

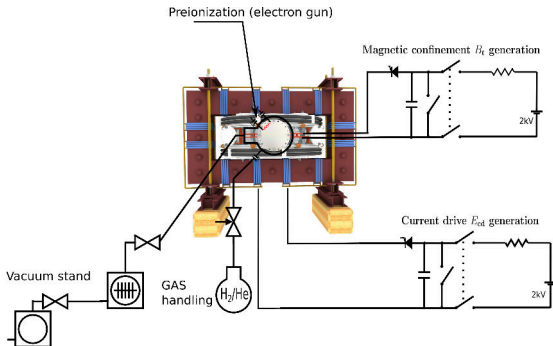

## To do:

- session start phase:
  - Evacuate the chamber
- pre-discharge phase
  - Charge the capacitors
  - Fill in the working gas
  - Preionization
- discharge phase
  - Trigger Magnetic confinement & Current drive
  - Plasma positioning
  - Diagnostics
- post-discharge phase
  - Data collection & analysis
  - Shot homepage creation



# Plasma in Tokamak (GOLEM) - the least to do

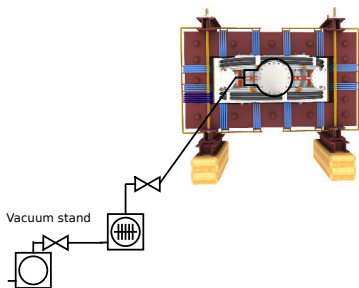

## To do:

- session start phase:
  - **Evacuate the chamber**
- pre-discharge phase
  - Charge the capacitors
  - Fill in the working gas
  - Preionization
- discharge phase
  - Trigger Magnetic confinement & Current drive
  - Plasma positioning
  - Diagnostics
- post-discharge phase
  - Data collection & analysis
  - Shot homepage creation

# Plasma in Tokamak (GOLEM) - the least to do

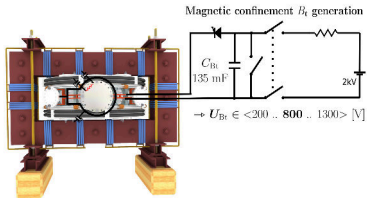

## To do:

- session start phase:
  - Evacuate the chamber
- pre-discharge phase
  - **Charge the capacitors**
  - Fill in the working gas
  - Preionization
- discharge phase
  - Trigger Magnetic confinement & Current drive
  - Plasma positioning
  - Diagnostics
- post-discharge phase
  - Data collection & analysis
  - Shot homepage creation

# Plasma in Tokamak (GOLEM) - the least to do

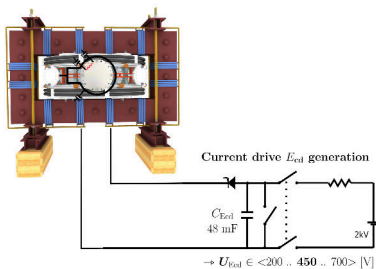

## To do:

- session start phase:
  - Evacuate the chamber
- pre-discharge phase
  - **Charge the capacitors**
  - Fill in the working gas
  - Preionization
- discharge phase
  - Trigger Magnetic confinement & Current drive
  - Plasma positioning
  - Diagnostics
- post-discharge phase
  - Data collection & analysis
  - Shot homepage creation

# Plasma in Tokamak (GOLEM) - the least to do

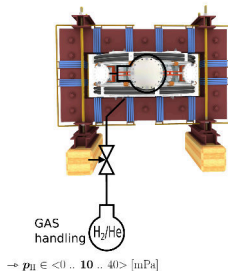

## To do:

- session start phase:
  - Evacuate the chamber
- pre-discharge phase
  - Charge the capacitors
  - **Fill in the working gas**
  - Preionization
- discharge phase
  - Trigger Magnetic confinement & Current drive
  - Plasma positioning
  - Diagnostics
- post-discharge phase
  - Data collection & analysis
  - Shot homepage creation

# Plasma in Tokamak (GOLEM) - the least to do

Preionization (electron gun)

→  $S/W_{\text{preion}} \in \langle \text{on} \dots \text{off} \rangle [-]$

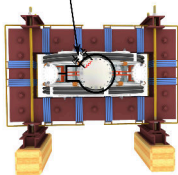

## To do:

- session start phase:
  - Evacuate the chamber
- pre-discharge phase
  - Charge the capacitors
  - Fill in the working gas
  - **Preionization**
- discharge phase
  - Trigger Magnetic confinement & Current drive
  - Plasma positioning
  - Diagnostics
- post-discharge phase
  - Data collection & analysis
  - Shot homepage creation

# Plasma in Tokamak (GOLEM) - the least to do

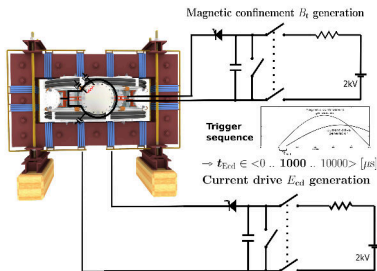

## To do:

- session start phase:
  - Evacuate the chamber
- pre-discharge phase
  - Charge the capacitors
  - Fill in the working gas
  - Preionization
- discharge phase
  - **Trigger Magnetic confinement & Current drive**
  - Plasma positioning
  - Diagnostics
- post-discharge phase
  - Data collection & analysis
  - Shot homepage creation

# Tokamak GOLEM - schematic experimental setup

Preionization (electron gun)

→  $S/W_{\text{preion}} \in \langle \text{on} \dots \text{on} \dots \text{off} \rangle [-]$

Magnetic confinement  $B_t$  generation

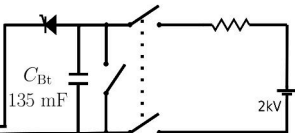

→  $U_{B_t} \in \langle 200 \dots 800 \dots 1300 \rangle [V]$

**Trigger sequence**

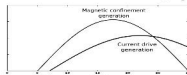

Current drive  $E_{cd}$  generation

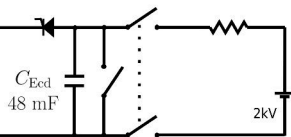

→  $U_{E_{cd}} \in \langle 200 \dots 450 \dots 700 \rangle [V]$

→  $t_{E_{cd}} \in \langle 0 \dots 1000 \dots 10000 \rangle [\mu s]$

Vacuum stand



GAS handling



→  $p_H \in \langle 0 \dots 10 \dots 40 \rangle [\text{mPa}]$

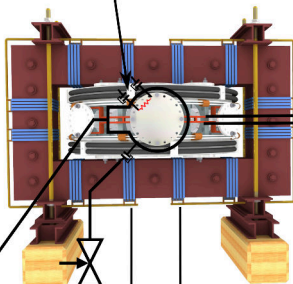

# Remote control interface of the GOLEM tokamak

Introduction Working gas Preionization Magnetic field Electric field Submit

Set the pressure and type of the working gas from which the plasma is formed. Pressure must be high enough for plasma to form, but low enough for gas breakdown to occur.

Preionization (electron gun)

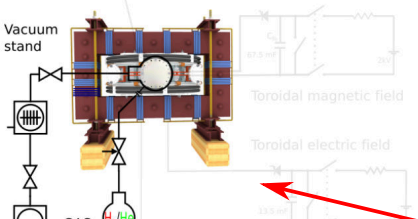

Vacuum stand

Toroidal magnetic field

Toroidal electric field

GAS handling

Gas type and pressure  $p_{WG} = 16 \text{ mPa}$

Hydrogen Helium

Next Set recommended value

rendering settings

3D model rendering method: Static image (fast) Interactive X3DOM (slower)

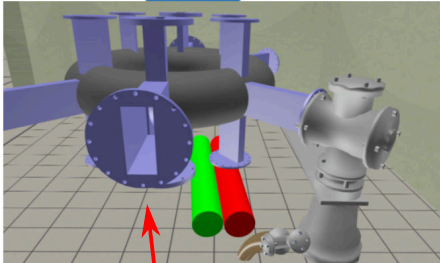

3D model rendering

engineering scheme

sliders and checkboxes

workflow buttons



Let's make a discharge

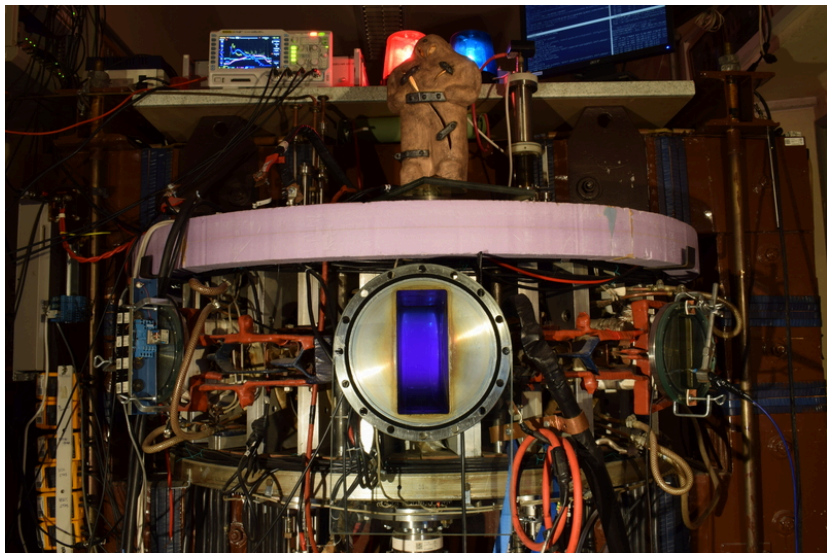

# Table of Contents

## 1 Introduction

## 2 The Tokamak (GOLEM)

- The GOLEM tokamak concept
- The scenario to make the (GOLEM) tokamak discharge
- The scenario to discharge virtually
- The GOLEM tokamak - guide tour
- The GOLEM tokamak basic diagnostics

## 3 The Tokamak GOLEM (remote) operation

## 4 Conclusion

## 5 Appendix

Introduce the working gas (Hydrogen x Helium)

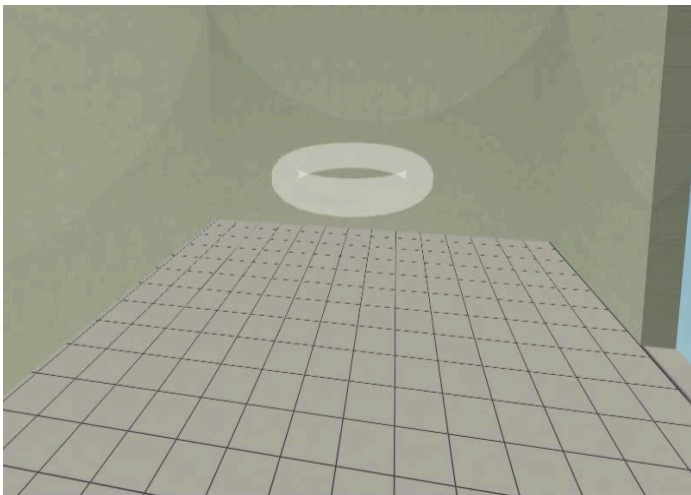

Switch on the preionization

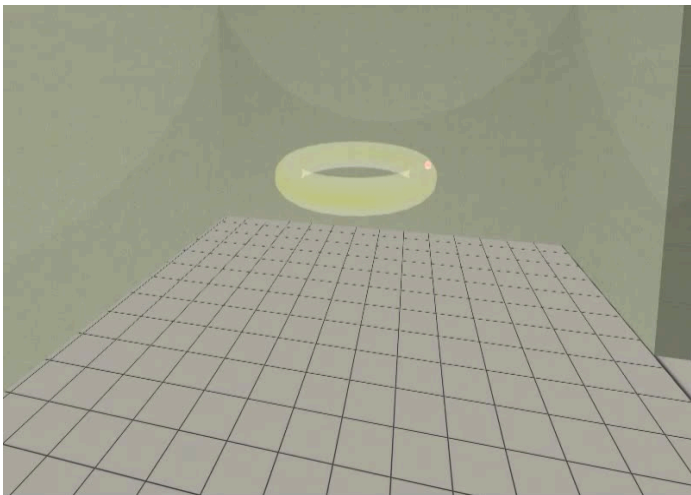

# Introduce the magnetic field

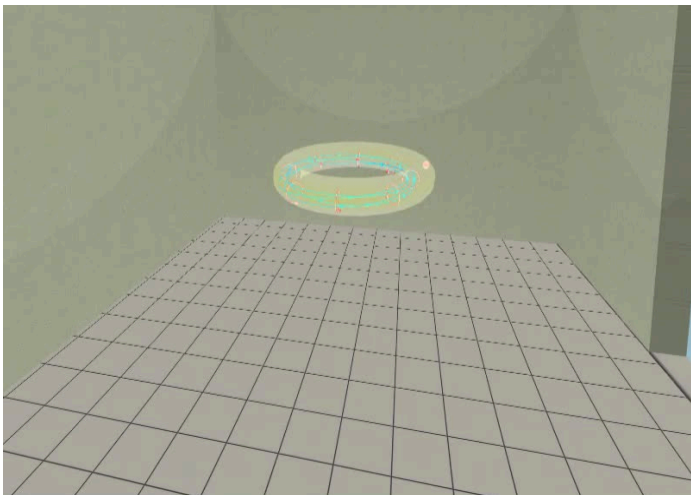

# Introduce the electric field

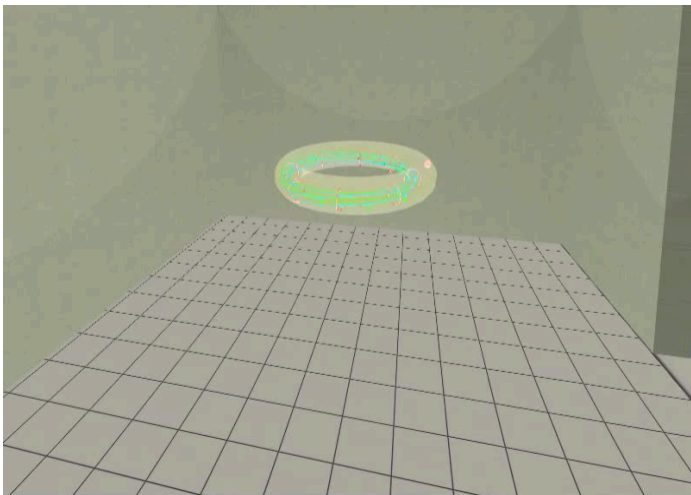

# Plasma ..

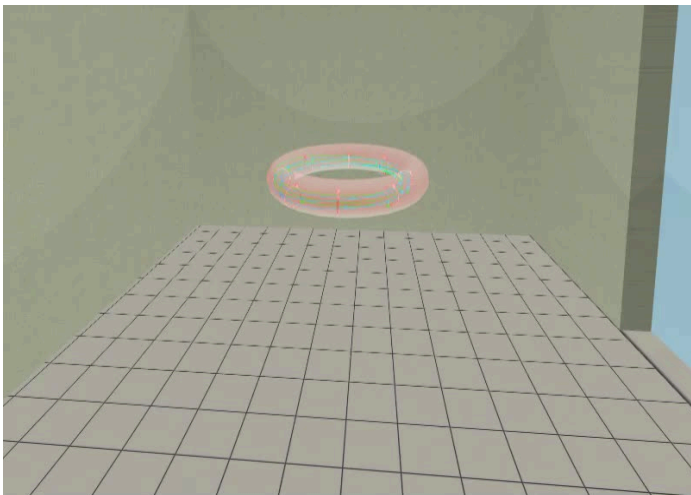

# Table of Contents

## 1 Introduction

## 2 The Tokamak (GOLEM)

- The GOLEM tokamak concept
- The scenario to make the (GOLEM) tokamak discharge
- The scenario to discharge virtually
- The GOLEM tokamak - guide tour
- The GOLEM tokamak basic diagnostics

## 3 The Tokamak GOLEM (remote) operation

## 4 Conclusion

## 5 Appendix



# Infrastructure room (below tokamak) 10/16



# Infrastructure room (below tokamak) 10/16

Current drive CD field  
and toroidal magnetic Bt field  
circuits

To the tokamak  
GOLEM

Rotary  
pump

Vacuum  
control

Current drive CD  
capacitors

Plasma  
stabilization

power  
supply  
2kV

Toroidal  
magnetic field B  
capacitors

fire  
protection  
system



# Tokamak room (North) 10/16



# Tokamak room (North) 10/16

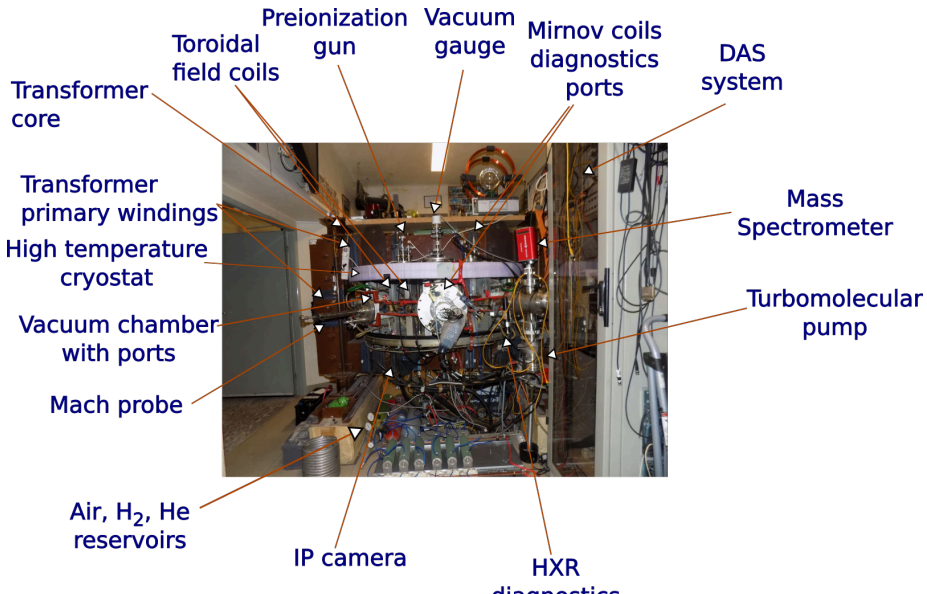

# Tokamak room (South) 10/16

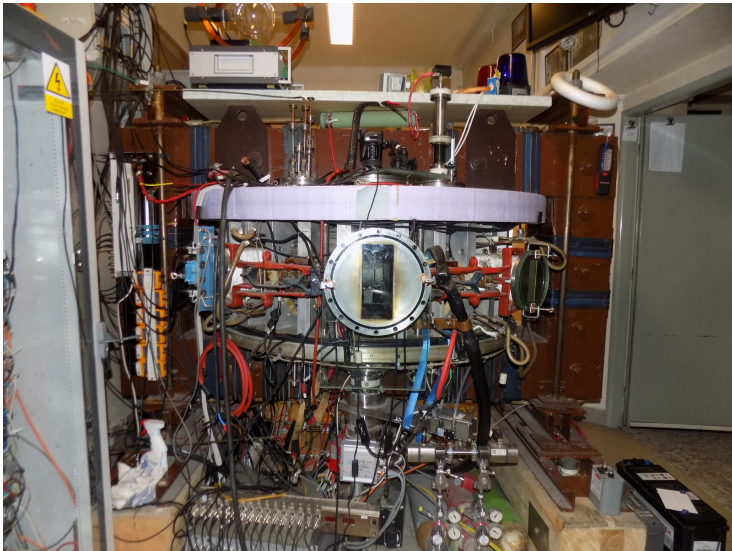

# Tokamak room (South) 10/16

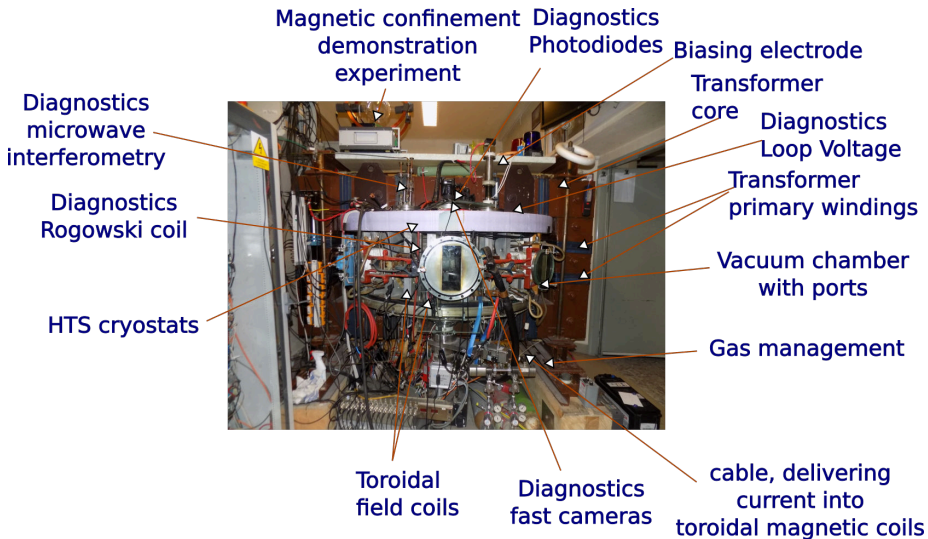

# Table of Contents

## 1 Introduction

## 2 The Tokamak (GOLEM)

- The GOLEM tokamak concept
- The scenario to make the (GOLEM) tokamak discharge
- The scenario to discharge virtually
- The GOLEM tokamak - guide tour
- The GOLEM tokamak basic diagnostics

## 3 The Tokamak GOLEM (remote) operation

## 4 Conclusion

## 5 Appendix

# The GOLEM tokamak - basic diagnostics

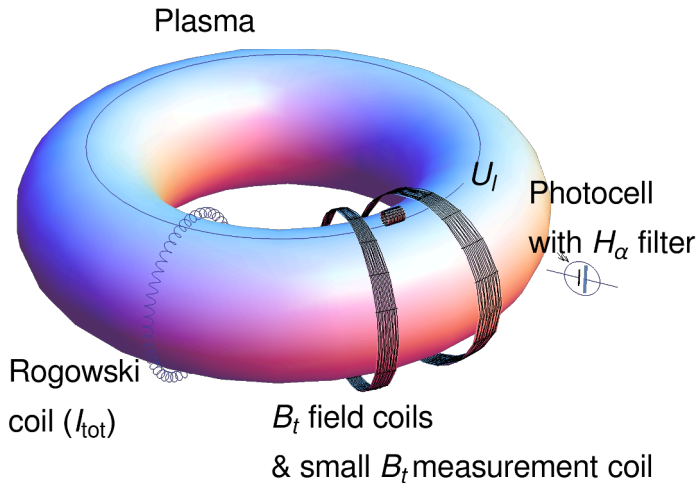



# Hands on the GOLEM tokamak - equipment



# Basic diagnostics - numerical processing, shot homepage

GOLEM - Shot #39187

## Tokamak GOLEM - Shot Database - #39187

The date of discharge execution: 22-05-18 17:55:04

The session mission: GOLEM II -> EDU (MHD + biasing)

The session ID: 39183

The discharge comment: Vert & Rad Stab

Discharge command: `loop j,Drigent.sh --discharge --UBT 1200 --TBT 0 --Ucd 450 --Tcd 350 --preionization 1 --gas H --pressure 10 --diagnostics.limitermirrorcoils "vacuum_shot=39109" --discharge.preionization "main_switch='on',powsup_heater=80,powsup_accel=100" --discharge.position_stabilization "main_switch='on',radial_switch='on',vertical_wavemode='3000,0,9000,-20:18000,0,20000,0,30000,0',vertical_switch='on',radial_wavemode='2000,0,3000,0,8000,-20:18000,0,19000,0,25000,0'" --ScanDefinition "39184 39185" --comment "Vert & Rad Stab"`

### Technological parameters

- Working Gas:  $p_{\text{discharge, before}} = 1,66 \text{ mPa}$ ;  $p_{\text{discharge, post}} = 10,40 \text{ mPa}$  ( $p_{\text{HWC}}^{\text{request}} = 10 \text{ mPa}$  @  $A_{\text{HWC}}^{\text{request}} = 4 \text{ H}$ )
- Toroidal magnetic field:  $U_{\text{BI}}^{\text{request}} = 1200 \text{ V}$  @  $I_{\text{BI}}^{\text{request}} = 0,0 \text{ us}$
- Current drive field:  $U_{\text{CD}}^{\text{request}} = 450 \text{ V}$  @  $I_{\text{CD}}^{\text{request}} = 350,0 \text{ us}$

### Plasma

- Plasma: yes or no:
- Time parameters:  $\Delta t_p = 15,08 \text{ ms}$  (from:  $t_{\text{start}} = 2,49 \text{ ms}$ , to:  $t_{\text{end}} = 17,57 \text{ ms}$ )

### Plasma parameters

- Loop voltage:  $U_{\text{loop}} = 8,02 \text{ V}$ ;  $\max_{r \in [0, \text{discharge}]} U_{\text{loop}} = 9,89 \text{ V}$ ;  $U_{\text{loop, down}} = 10,83 \text{ V}$
- Toroidal magnetic field:  $B_t = 0,40 \text{ T}$ ;  $\max_{r \in [0, \text{discharge}]} B_t = 0,57 \text{ T}$
- Plasma current:  $I_p = 9,57 \text{ kA}$ ;  $\max_{r \in [0, \text{discharge}]} I_p = 9,57 \text{ kA}$ ;  $I_{\text{CD}} = 11,66 \text{ kA}$

GOLEM - Shot #39187

## On stage diagnostics

Data flow: measurement → digitization → analysis

Name	Experiment setup	Data acquisition system	Raw data	Analysis results
Basic Diagnostics				

# Basic diagnostics - numerical processing, raw data

The image shows a web browser displaying a diagnostics interface for a Golem system. The top part of the browser shows a graph with a blue line and a red vertical line. Below the graph is a navigation menu with sections like 'Diagnostics', 'Other', and 'Navigation'. The main content area is titled 'On stage diagnostics' and features a flow diagram with stages: 'Data flow', 'measurement', 'digitization', and 'analysis'. A red circle highlights a specific data point in the 'analysis' stage. Below the browser window is a file index for the directory '/shots/39187/Devices/Oscilloscopes/TektrMSO56-a'. The index table lists files such as 'BasicDiagnostics.sh', 'ScreenShotAll.png', 'TektrMSO56\_ALL.csv', 'Universals.sh', 'das.jpg', 'ls-all', and 'rawdata.jpg'. A red arrow points from the highlighted data point in the browser to the 'BasicDiagnostics.sh' file in the index. Another red arrow points from the left side of the image to the 'BasicDiagnostics.sh' file. At the bottom of the index, it says 'Apache/2.4.38 (Debian) Server at golem.fjfi.cvut.cz Port 80'.

Index of /shots/39187/Devices/Oscilloscopes/TektrMSO56-a

Name	Last modified	Size	Description
<a href="#">Parent Directory</a>	-	-	-
<a href="#">BasicDiagnostics.sh</a>	2022-05-18 17:58	3.2K	
<a href="#">ScreenShotAll.png</a>	2022-05-18 17:58	184K	
<a href="#">TektrMSO56_ALL.csv</a>	2022-05-18 17:58	3.9M	
<a href="#">Universals.sh</a>	2022-05-18 17:58	1.2K	
<a href="#">das.jpg</a>	2022-05-18 17:58	13K	
<a href="#">ls-all</a>	2022-05-18 17:58	2.4K	
<a href="#">rawdata.jpg</a>	2022-05-18 17:58	13K	

Apache/2.4.38 (Debian) Server at golem.fjfi.cvut.cz Port 80

# Basic diagnostics - numerical processing, Jupyter-notebook@GitLab Download & play

The screenshot displays a GitLab repository page for the project 'Tokamak GOLEM Basic diagnostics'. The top navigation bar includes 'About GitLab', 'Pricing', 'Talk to an expert', and a search bar. A sidebar on the left lists repository features like 'Files', 'Commits', and 'Issues'. The main content area shows the notebook file 'StandardDAS.ipynb' (19.83 KIB) with a download icon and an 'Open in Web IDE' button. The notebook title is 'Tokamak GOLEM Basic diagnostics', followed by a procedure link and prerequisites for function definitions. The code block shows the following imports:

```
%matplotlib inline
import os
import numpy as np
import matplotlib.pyplot as plt
from scipy import constants, integrate, signal, interpolate
import sqlalchemy # high-level library for SQL in Python
import pandas as pd
import subprocess
```

A red arrow points from a circular icon in the notebook preview to the title of the notebook in the main content area.

# Basic diagnostics - numerical processing, Jupyter-notebook applied on the Discharge #



Procedure ([This notebook to download](#))

[bash wrapper](#), [Error log](#)

### Prerequisites: function definitions

Load libraries

```
In [1]: %matplotlib inline
import os
import numpy as np
import matplotlib.pyplot as plt
from scipy import constants, integrate, signal, interpolate
import sqlalchemy # high-level library for SQL in Python
import pandas as pd
import subprocess
```

For interactive web figures

```
In [2]: import holoviews as hv
hv.extension('bokeh')
import hvplot.pandas
```



For conditional rich-text boxes

```
In [3]: from IPython.display import Markdown
```

# Loop voltage $U_l$ @ the GOLEM tokamak

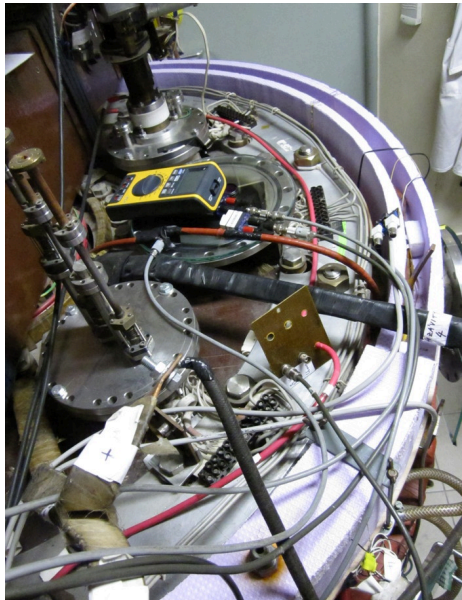
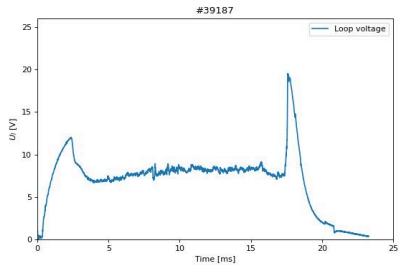
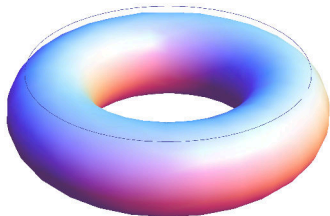

# Basic diagnostics - numerical processing, $U_{loop}$

```
t_scale = 1e-3 if in_seconds else 1
if is_plasma:
    for t in (t_plasma_start, t_plasma_end):
        plt.axvline(t = t_scale, color='k', linestyle='--')
```

## $U_l$ management

Check the data availability

```
In [11]: loop_voltage = read_signal(shot_no, 'U_Loop')
polarity_CD = read_parameter(shot_no, 'CD_orientation')
if polarity_CD != 'CW': # T000 hardcoded for now!
    loop_voltage *= -1 # make positive
loop_voltage = correct_inf(loop_voltage)
loop_voltage.loc[is_CD] = 0
ax = loop_voltage.plot(grid=True)
show_plasma_limits()
ax.set(xlabel='Time [s]', ylabel='SU_LS [V]', title='Loop voltage SU_LS #{}'.format(shot_no));
```

```
Out[11]: [Text(0.5, 0, 'Time [s]'),
Text(0, 0.5, 'SU_LS [V]'),
Text(0.5, 1.0, 'Loop voltage SU_LS #39187')]
```

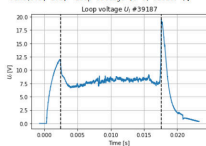

## $B_t$ calculation

Check the data availability

It is as magnetic measurement, so the raw data only give  $\frac{dB_t}{dt}$

```
In [12]: dBt = read_signal(shot_no, 'U_BtCoil')
polarity_BT = read_parameter(shot_no, 'BT_orientation')
if polarity_BT != 'CW': # T000 hardcoded for now!
    dBt *= -1 # make positive
dBt = correct_inf(dBt)
dBt -= dBt.loc[offset_s1].mean()
ax = dBt.plot(grid=True)
show_plasma_limits()
ax.set(xlabel='Time [s]', ylabel='dBt [V]', title='BTCoil raw signal #{}'.format(shot_no));
```

# Toroidal magnetic field $B_t$ @ the tokamak GOLEM

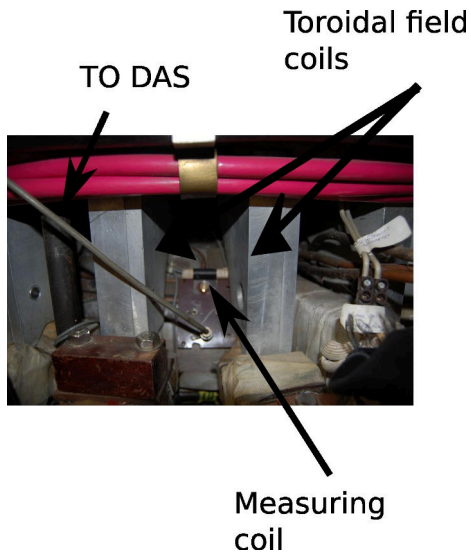
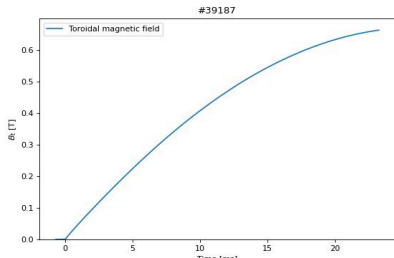



# Basic diagnostics - numerical processing, $B_t$

## $B_t$ calculation

### Check the data availability

It is as magnetic measurement, so the raw data only give  $\frac{dB_t}{dt}$

```
In [12]: dBt = read_signal(shot_no, '0_BtCoil')
polarity_Bt = read_parameter(shot_no, 'Bt_orientation')
if polarity_Bt != 'CW':
    dBt *= -1 # make positive # 1000 hardcoded for now!
dBt = correct_infidBt
dBt = dBt.loc[offset_start:]
ax = dBt.plot(grid=True)
show_plasma_limits()
ax.set(xlabel='Time [s]', ylabel='dBt [B/s]', title='BtCoil_raw signal #{}'.format(shot_no));
```

```
Out[12]: [Text(0.5, 0, 'Time [s]'),
Text(0, 0.5, 'dBt [B/s]', title='BtCoil_raw signal #39187')]
Text(0.5, 1.0, 'BtCoil_raw signal #39187')]
```

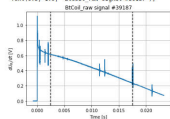

### Integration (it is a magnetic diagnostic) & calibration

```
In [13]: K_BtCoil = float(read_parameter(shot_no, 'SystemParameters/K_BtCoil')) # Get BtCoil calibration factor
print('BtCoil calibration factor K_BtCoil={}'.format(K_BtCoil))
BtCoil calibration factor K_BtCoil=70.42 T/V/s)
```

```
In [14]: BT = pd.Series(integrate.cumtrapz(dBt, axis=dBt.index, initial=0) * K_BtCoil,
index=dBt.index, name='Bt')
ax = BT.plot(grid=True)
show_plasma_limits()
ax.set(xlabel='Time [s]', ylabel='Bt [T]', title='Toroidal magnetic field Bt ts #{}'.format(shot_no));
```

```
Out[14]: [Text(0.5, 0, 'Time [s]'),
Text(0, 0.5, 'Bt [T]', title='Toroidal magnetic field Bt ts #39187')]
Text(0.5, 1.0, 'Toroidal magnetic field Bt ts #39187')]
```

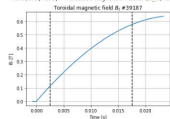

# Total current $I_{ch+p}$

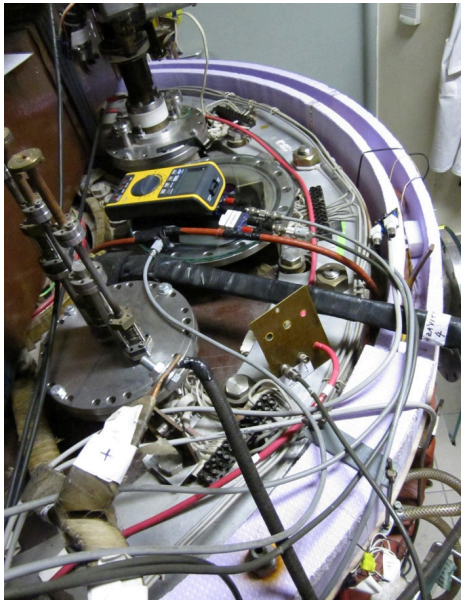
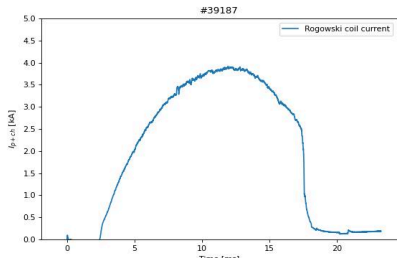
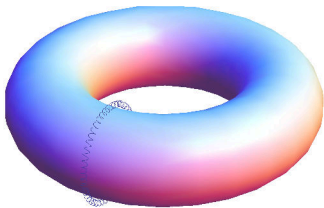

# Basic diagnostics - numerical processing, $U_{ch+p}$

Chamber (+ Plasma) current  $I_{p+ch}$  calculation

The Rogowski coil around the chamber measures the total current contained within its boundaries. Therefore, if there is plasma, it measures the sum of the plasma and chamber currents. In a vacuum discharge it measures only the chamber current.

Check the data availability

Because it is a magnetic measurement, the raw data only gives  $\frac{dI_{p+ch}}{dt}$

```
In [131]: dIpcch = read_signal(shot_no, 'RogCoil') # 5000 horizontal for now
if dIpcch[0] == 0:
    dIpcch *= 1 # zero sensitive
dIpcch = correct_bias(dIpcch)
dIpcch = dIpcch.loc[('start', 0), :] # subtract offset
dIpcch.loc[:, 'dI'] = 0
ax = dIpcch.plot(grid=True)
show_plasma_limits()
ax.set(xlabel='Time [s]', ylabel='dI [pA/s]', title='RogowskiCoil_raw_signal_#131'.format(shot_no))
```

Integration (it is a magnetic diagnostic) & calibration

```
In [130]: K_RogowskiCoil = float(read_parameter(shot_no, 'SystemParameters/K_RogowskiCoil')) # Get RogowskiCoil calibration factor
print('RogowskiCoil calibration factor: K_RogowskiCoil={0:10.5}'.format(K_RogowskiCoil))
In [132]: Spch = pd.Series(integrate.cumtrapz(dIpcch, width=0.001, initial=0) * K_RogowskiCoil,
                        index=dIpcch.index, name='Spch')
ax = Spch.plot(grid=True)
show_plasma_limits()
ax.set(xlabel='Time [s]', ylabel='SI [pA]', title='Total (plasma+chamber) current SI [pA]'.format(shot_no))
```

Chamber current  $I_{ch}$  calculation

```
In [130]: K_chamber = float(read_parameter(shot_no, 'SystemParameters/K_chamber')) # Get Chamber resistivity
print('Chamber resistivity: K_chamber={0}'.format(K_chamber))
Chamber resistivity: K_chamber=0.007 Ohm
In [131]: I_chamber = float(read_parameter(shot_no, 'SystemParameters/I_chamber')) # Get Chamber inductance
print('Chamber inductance: I_chamber={0}'.format(I_chamber))
Chamber inductance: I_chamber=4e-06 H
```

```
In [131]: for i in range(1, len(shots)):
ax = I.plot(i)
ax.legend()
show_plasma_limits(i)
ax.set(xlabel='Time [s]', ylabel='SI [A]', title='estimated chamber current and measured total')
plt.grid(i)
```

Plasma current  $I_p$  calculation

If there is plasma, the plasma current can be estimated as the difference between the total measured current and the estimated chamber current  $I_p = I_{p+ch} - I_{ch}$

```
In [122]: if is_plasma:
    Ip_name = Ipch - loop_voltage/R_chamber # creates a new Series
    Ip = Ipch - I_ch
    Ip_name = 'Ip'
    Ip_name.plot(grid=True, label='naive SI (ch)+I (ch)')
    ax = Ip.plot(grid=True, label='using SQ_L = R_ch I_ch - L_ch / (frac(1, (ch))dt)')
    ax.legend()
    show_plasma_limits()
    ax.set(xlabel='Time [s]', ylabel='SI [pA]', title='Plasma current SI (p)'.format(shot_no))
else:
    Ip = Ipch * 0 # no current
    heating
```

Out[122]: Plasma detected

plasma lifetime of 15.1 ms, from 2.5 ms to 17.6 ms

```
In [131]: fig = plt.figure(dpi=200)
for i in range(1, len(shots)):
    ax = I.plot(i)
```

# Visible radiation

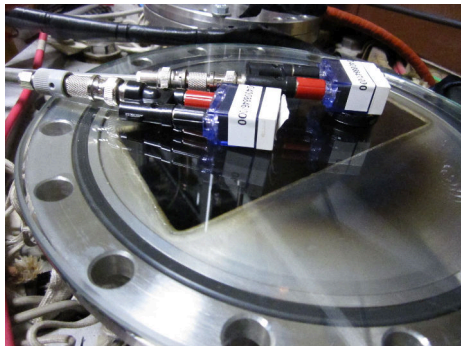
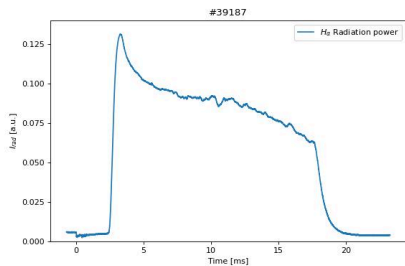
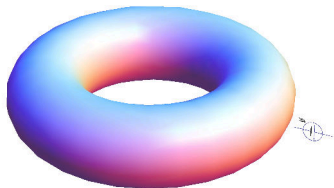

# Electron density $n_e$ interferometry measurement scheme

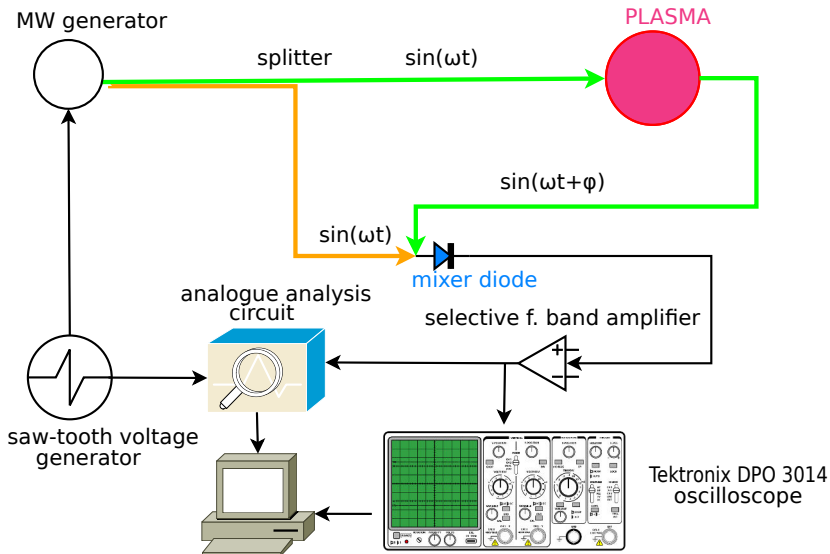

# The GOLEM tokamak interferometry HW

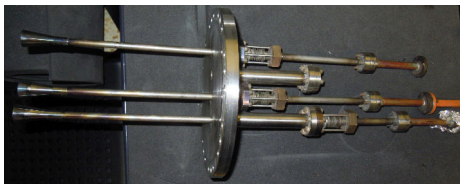

# Finally "Typical", well executed discharge @ GOLEM

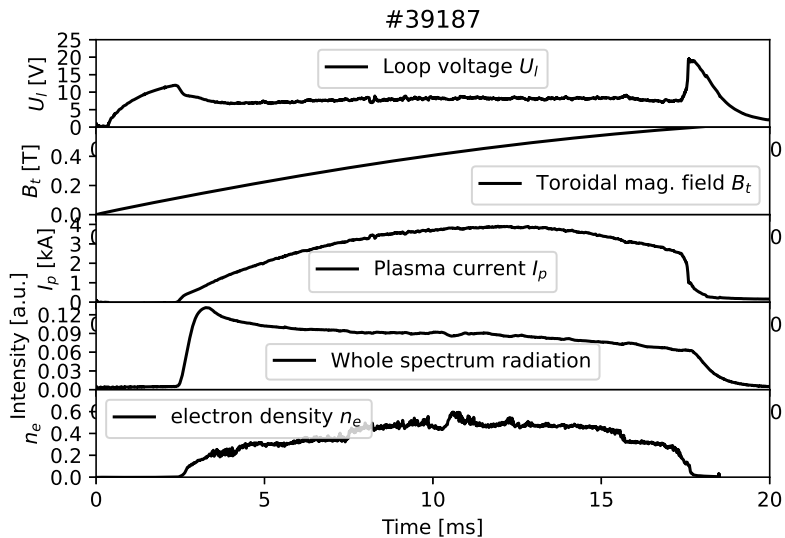

# Shot homepage ( $\approx 2$ minutes after discharge execution)

GOLEM # Shot #40631
autoreload



**Diagnostics**

BasicDiagnostics  
DoubleRakeProbe  
Interferometry  
LimiterFlareCoils  
ScribbleProbes

**Other**

View Showroom

**Navigation**

Next  
Previous  
Current

**Go to shot**  
40631

**GOLEM utils**

Home  
Plot data  
Shot manual plot  
Manipulators control

**Database operations**

Shots listing  
Shots filtering

## Tokamak GOLEM - Shot Database - #40631

**The date of discharge execution** 23-02-07 17:23:54

**The session mission** 1Final -> Dringent service

**The session ID** 40605

**The discharge comment** Rake probe 50mm

**Discharge command**

[Shot Logbook]

```

jDringent.sh --discharge --UBt 800 --Tbt 0 --Utd 450 --Tod 500 --preionization 1 --gas H --pre
issue 13 --diagnostics.limiterflarescoils.vacuum_shot=40615 --discharge.preionization "m
in_switch=on;radial_heater=80;powsupp_accel=100" --infrastructure.position_stabilization
"main_switch=on;radial_switch=on;vertical_waveform=1000,0.8000,-20,10000,-25,12000,-
10,30000,0;vertical_switch=on;radial_waveform=2000,0.3000,0.7000,-20,9500,-25,10000,-
20,30000,2,25000,0" --ScanDefinition 40625 40629 --comment "Rake probe 50mm"
                    
```

### Technological parameters

- Working Gas:  $P_{discharge,befire} = 2.46$  mPa;  $P_{discharge,pre} = 5.04$  mPa ( $P_{WG}^{response} = 15$  mPa@ $\Delta T_{WG}^{response} = H$ )
- Toroidal magnetic field:  $U_{B_t}^{response} = 800$  V@ $I_{B_t}^{response} = 0.0$  us
- Current drive field:  $U_{Eca}^{response} = 450$  V@ $I_{Eca}^{response} = 500.0$  us















### Plasma:

- Plasma: yes or no:
- Time parameters:  $\Delta T_p = 10.88$  ms ( $t_{rom,start} = 2.67$  ms,  $t_{rom,end} = 13.54$  ms)

### Plasma parameters:

- Loop voltage:  $U_{loop} = 6.82$  V;  $max_{T_{loop}}(I_{discharge}) U_{loop} = 16.17$  V;  $U_{breakdown} = 0.00$  V
- Toroidal magnetic field:  $B_t = 0.24$  T;  $max_{T_{loop}}(I_{discharge}) B_t = 0.36$  T
- Plasma current:  $I_p = 2.28$  kA;  $max_{T_{loop}}(I_{discharge}) I_p = 2.92$  kA;  $t_p^{max} = 0.00$  ms

### On stage diagnostics

Data flow	measurement	digitization	analysis	Analysis results
Name	Experiment setup	Data acquisition system	Raw data	
<b>Basic Diagnostics</b>  				
				
<b>Double rake probe</b>  				

## Basic Diagnostics

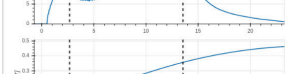
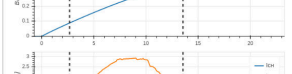

# Table of Contents

- 1 Introduction
- 2 The Tokamak (GOLEM)
- 3 The Tokamak GOLEM (remote) operation**
- 4 Conclusion
- 5 Appendix

# Table of Contents

- 1 Introduction
- 2 The Tokamak (GOLEM)
- 3 The Tokamak GOLEM (remote) operation**
  - Control room
  - Data handling @ the Tokamak GOLEM
- 4 Conclusion
- 5 Appendix

# Tokamak GOLEM - schematic experimental setup

Preionization (electron gun)

→  $S/W_{\text{preion}} \in \langle \text{on} \dots \text{on} \dots \text{off} \rangle [-]$

Magnetic confinement  $B_t$  generation

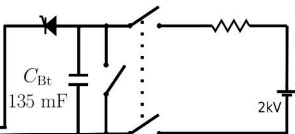

→  $U_{B_t} \in \langle 200 \dots 800 \dots 1300 \rangle [V]$

**Trigger sequence**

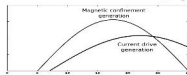

Current drive  $E_{cd}$  generation

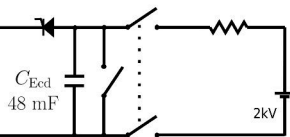

→  $U_{E_{cd}} \in \langle 200 \dots 450 \dots 700 \rangle [V]$

→  $t_{E_{cd}} \in \langle 0 \dots 1000 \dots 10000 \rangle [\mu s]$

Vacuum stand



GAS handling



→  $p_H \in \langle 0 \dots 10 \dots 40 \rangle [\text{mPa}]$

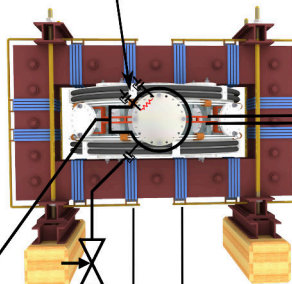

# Remote control interface of the GOLEM tokamak

Introduction Working gas Preionization Magnetic field Electric field Submit

Set the pressure and type of the working gas from which the plasma is formed. Pressure must be high enough for plasma to form, but low enough for gas breakdown to occur.

Preionization (electron gun)

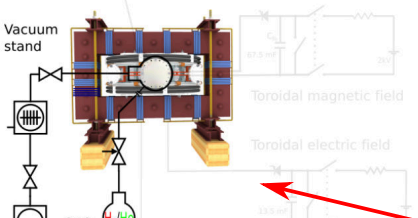

Vacuum stand

Toroidal magnetic field

Toroidal electric field

GAS handling

Gas type and pressure  $p_{WG} = 16 \text{ mPa}$

Hydrogen Helium

Next Set recommended value

3D model rendering method: Static image (fast) Interactive X3DOM (slower) rendering settings

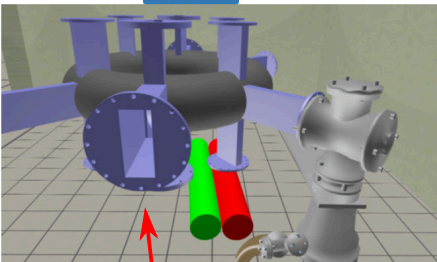

3D model rendering

engineering scheme

sliders and checkboxes

workflow buttons

# Control room: Introduction

GOLEM remote Introduction **Control room** Live Results

Prague Access: Level 1 Help

Introduction Working gas Preionization Magnetic field Current drive Submit

This web interface will walk you through the process of configuring a discharge in the GOLEM tokamak. All settable values are perfectly safe. Proceed through each step by setting the desired values and then clicking the [Next](#) button. You can always go to a specific step by clicking its tab.

**Preionization (electron gun)**

Vacuum stand

Preionization (electron gun)

Toroidal magnetic field

Current drive

GAS  $H_2/He$  handling

23 mF  $C_p$

11.3 mF  $C_p$

2kV

2kV

3D model rendering method: **Static image (fast)** Interactive X3DOM (slower)

# Control room: Working gas

GOLEM remote Introduction Control room Live Results

Introduction Working gas Preionization Magnetic field Electric field Submit

Set the pressure and type of the working gas from which the plasma is formed. Pressure must be high enough for plasma to form, but low enough for gas breakdown to occur.

### Preionization (electron gun)

Vacuum stand

GAS handling

Toroidal magnetic field

Toroidal electric field

Gas type and pressure  $p_{\text{gas}} = 38 \text{ mPa}$

Hydrogen Helium

Next Set recommended value

3D model rendering method Static image (best) Interactive X3DOM (preview)

# Control room: Preionization

GOLEM remote Introduction Control room Live Results

Introduction Working gas Preionization Magnetic field Electric field Submit

The neutral working gas must be first ionized in order to break down into a plasma. Using the electron gun will locally ionize the gas. Without any ionization, no plasma can form.

### Preionization (electron gun)

Vacuum stand

GAS handling

Toroidal magnetic field

Toroidal electric field

67.5 mT

13.5 mV

200V

200V

ionization method

Electron gun  No ionization

Next

3D model rendering method Static image (best) Interactive X3DOM (viewer)

[https://golem.fk.cvut.cz/remote/control\\_room/?access\\_token=82d74f733d4770040ce77821158602c2&identifier=Master#control-sub-preion](https://golem.fk.cvut.cz/remote/control_room/?access_token=82d74f733d4770040ce77821158602c2&identifier=Master#control-sub-preion)

# Control room: Magnetic field $B_t$

GOLEM version: Introduction Control room Live Results

Press F11 to exit full screen  
3D model rendering method: Static image (best) Interactive X3DOM (viewer)

Introduction Working gas Preionization **Magnetic field** Electric field Submit

Set the voltage on the capacitors to be discharged into the toroidal field coils. The higher the voltage, the larger the magnetic field confining the plasma.

Preionization (electron gun)

Vacuum stand

Toroidal magnetic field

Toroidal electric field

GAS handling

Capacitor voltage  $U_{C_1} = 600\text{ V}$

Next Set recommended value

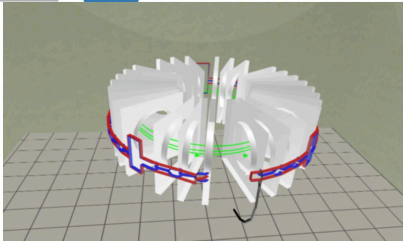

The image shows a 3D rendering of the toroidal magnetic field coils. The coils are arranged in a toroidal shape, with a central vertical axis. The coils are colored in shades of white and grey, with red and blue lines indicating the direction of the magnetic field. The rendering is set against a simple background with a grey floor grid.



# Control room: Current drive $E_{cd}$

GOLEM remote Introduction Control room Live Results

the Torneo Politecnico, Italy Group 1 Access: Level 2 Help

Introduction Working gas Preionization Magnetic field **Electric field** Submit

Set the voltage on the capacitors to be discharged into the [primary transformer winding](#). The higher the voltage, the larger the electric field creating and heating the plasma. The electric field capacitors are discharged after a configurable delay with respect to the magnetic field capacitors.

Preionization (electron gun)

Vacuum stand

Toroidal magnetic field

Toroidal electric field

GAS handling

Time delay of electric field start after the magnetic field starts  $t_{\text{cd}}$ : 0 micro seconds

Capacitor voltage  $U_{\text{cd}}$ : 400 V

Next Set recommended value

3D model rendering method Static image (best) Interactive X3DOM (viewer)

# Control room: ... and Submit

GOLEM remote Introduction Control room Live Results

the Torneo Politecnico, Italy Group 1 Access: Level 2 Help

Introduction Working gas Preionization Magnetic field Electric field **Submit**

Write a comment describing your discharge configuration, i.e. the scientific aim of your experiment. Or just leave a friendly message.

Comment

Click the Submit button to send your configuration into the queue. **Submit**

After submission you can watch the discharge Live or go back to the Introduction tab and start again. Or you can go to specific control tabs and reconfigure the discharge and then submit another discharge request.

[Watch the discharge Live!](#) [Go back to Introduction](#)

3D model rendering method: [Static image \(best\)](#) [Interactive X3DOM \(slower\)](#)

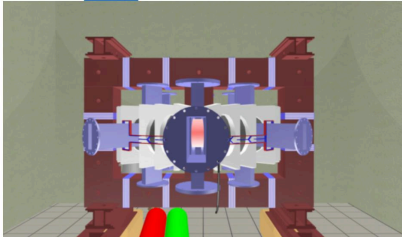

# Shot homepage ( $\approx 2$ minutes after discharge execution)

GOLEM # Shot #40631
autoreload



**Diagnostics**

BasicDiagnostics  
DoubleRakeProbe  
Interferometry  
LimiterFlareV coils  
ScribbleProbes

**Other**

View Showroom

**Navigation**

Next  
Previous  
Current

**Go to shot**  
40631

**GOLEM utils**

Home  
Plot data  
Shot interval plot  
Manipulators control

**Database operations**

Shots listing  
Shots filtering

## Tokamak GOLEM - Shot Database - #40631

**The date of discharge execution** 23-02-07 17:23:54

**The session mission** 1Final -> Dringent service

**The session ID** 40605

**The discharge comment** Rake probe 50mm

**Discharge command**

[Shot Logbook]

```

jDringent.sh --discharge --UBt 800 --Tbt 0 --Utd 450 --Tod 500 --preionization 1 --gas H --pre
issue 13 --diagnostics.limiterflarev coils "vacuum_shot=40615" --discharge.preionization "m
in_switch=on;radial_heater=80;powsupp_accel=100" --infrastructure.position.stabilization
"main_switch=on;radial_switch=on;vertical_waveform=1000,0.8000,-20,10000,-25,12000,-
10,30000,0;vertical_switch=on;radial_waveform=2000,0.3000,0.7000,-20,9500,-25,10000,-
20,30000,2,25000,0" --ScanDefinition 40625 40629 --comment "Rake probe 50mm"
                    
```

### Technological parameters

- Working Gas:  $P_{discharge, before} = 2.46$  mPa;  $P_{discharge, after} = 5.04$  mPa ( $P_{WG}^{response} = 15$  mPa @  $\Delta P_{WG}^{response} = 4$ )
- Toroidal magnetic field:  $U_{B_t}^{response} = 800$  V @  $I_{B_t}^{response} = 0.0$  us
- Current drive field:  $U_{Ecd}^{response} = 450$  V @  $I_{Ecd}^{response} = 500.0$  us

### Plasma:

- Plasma: yes or no:
- Time parameters:  $\Delta t_p = 10.88$  ms ( $t_{rom_start} = 2.67$  ms,  $t_{rom_end} = 13.54$  ms)







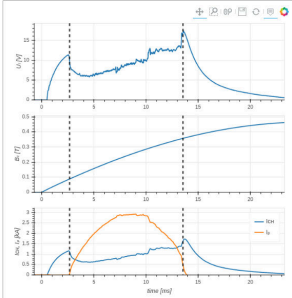



### Plasma parameters:

- Loop voltage:  $\bar{U}_{loop} = 6.82$  V;  $max_{T_{loop}}(I_{discharge}) U_{loop} = 16.17$  V;  $U_{breakdown} = 0.00$  V
- Toroidal magnetic field:  $B_t = 0.24$  T;  $max_{T_{discharge}}(I_{discharge}) B_t = 0.36$  T
- Plasma current:  $I_p = 2.28$  kA;  $max_{T_{discharge}}(I_{discharge}) I_p = 2.92$  kA;  $t_p^{max} = 0.00$  ms

## Basic Diagnostics



## On stage diagnostics

Data flow	measurement	digitization	analysis	Analysis results
Name	Experiment setup	Data acquisition system	Raw data	Analysis results
<b>Basic Diagnostics</b> 				
<b>Double rake probe</b> 				 <p><b>Without Analysis</b></p>

# Table of Contents

- 1 Introduction
- 2 The Tokamak (GOLEM)
- 3 The Tokamak GOLEM (remote) operation**
  - Control room
  - Data handling @ the Tokamak GOLEM
- 4 Conclusion
- 5 Appendix

# GOLEM basic Data Acquisition System (DAS)

- $U_I, U_{B_t}, U_{I_{p+ch}}, I_{rad}$
- $\Delta t = 1\mu s / f = 1MHz$ .
- Integration time = 40 ms, thus DAS produces 6 columns x 40000 rows data file.
- Discharge is triggered at 5th millisecond after DAS to have a zero status identification.



Data file example, DAS  $\Delta t = 1\mu s / f = 1MHz$  (neutral gas into plasma breakdown focused)

$t$	$\approx U_I$	$\approx U_{\frac{dB_T}{dt}}$	$\approx U_{\frac{d(I_{p+ch})}{dt}}$	$\approx I_{rad}$
:	:	:	:	:
:	:	:	:	:
first	$\approx$	7405	lines ..	:
:	:	:	:	:
:	:	:	:	:
0.007383	1.53931	0.390015	0.048828	0.001831
0.007384	1.53686	0.395508	0.067749	0.00061
0.007385	1.54053	0.391235	0.079956	0.00061
0.007386	1.53686	0.38147	0.072632	0
0.007387	1.54297	0.397949	0.059204	0.00061
0.007388	1.54053	0.384521	0.05249	0.00061
0.007389	1.54053	0.39856	0.068359	0.001221
0.00739	1.54053	0.393677	0.082397	0.001221
0.007391	1.53809	0.38208	0.072632	0.001221
0.007392	1.54297	0.400391	0.056763	0.00061
0.007393	1.54419	0.383911	0.053101	0.00061
0.007394	1.53931	0.397339	0.068359	0.001221
0.007395	1.54297	0.391846	0.084229	0.00061
0.007396	1.54541	0.394897	0.074463	0.00061
0.007397	1.54297	0.388184	0.056763	0.001221
0.007398	1.54297	0.391846	0.056763	0.00061
0.007399	1.54297	0.394287	0.06897	0.00061
:	:	:	:	:
:	:	:	:	:
next	$\approx$	32500	lines ..	:
:	:	:	:	:
:	:	:	:	:

# Data access

All the recorded data and the settings for each discharge (shot) are available at the GOLEM website. The root directory for the files is:

```
http://golem.fjfi.cvut.cz/shots/<#ShotNo>/
```

The most recent discharge has the web page:

```
http://golem.fjfi.cvut.cz/shots/0
```

Particular data from DAS specified with <DASname> and <DASchannelidentifier> have the format:

```
http:  
//golem.fjfi.cvut.cz/<#ShotNo>/<DASname>/<DASchannelidentifier>
```

# Jupyter (python)

```
import numpy as np
import matplotlib.pyplot as plt

shot_no = 39187
identifier = "U_loop.csv"
DAS='Diagnostics/BasicDiagnostics/Results/'
# create data cache in the 'golem_cache' folder
ds = np.DataSource('golem_cache')
#Create a path to data and download and open the file
base_url = "http://golem.fjfi.cvut.cz/shots/"
data_file = ds.open(base_url + str(shot_no)+ '/' +DAS +identifier)
#Load data from the file and plot to screen and to disk
data = np.loadtxt(data_file,delimiter=",")
plt.title('#'+str(shot_no))
plt.plot(data[:,0]*1000, data[:,1]) #1. column vs 2. column
plt.xlabel('Time [ms]');plt.ylabel('$U_1$ [V]');
plt.savefig('graph.jpg')
plt.show()

#Run it: save it as script.py and run "python script.py" or execute in a
```

# Matlab

```
ShotNo=39187
baseURL='http://golem.fjfi.cvut.cz/shots/';
diagnPATH='/Diagnostics/BasicDiagnostics/Results/U_loop.csv';
%Create a path to data
dataURL=strcat(baseURL,int2str(ShotNo),diagnPATH);
% Write data from GOLEM server to a local file
urlwrite(dataURL,'LoopVoltage');
% Load data
data = load('LoopVoltage', '\t');
% Plot and save the graph
f = figure('visible', 'off');
hold on
plot(data(:,1)*1000, data(:,2), '.');
xlabel('Time [ms]')
ylabel('U_1 [V]')
hold off
print -djpeg plot.jpg
close(f)
exit;
```



# Octave

```
ShotNo=39187
baseUrl='http://golem.fjfi.cvut.cz/shots/';
diagnPATH='/Diagnostics/BasicDiagnostics/Results/U_loop.csv';
%Create a path to data
dataURL=strcat(baseUrl,int2str(ShotNo),diagnPATH);
% Write data from GOLEM server to a local file
urlwrite(dataURL,'U_Loop.csv');
% Load data
data = load('U_Loop.csv', '\t');
% Plot and save the graph
plot(data(:,1)*1000, data(:,2), '.');
xlabel('time [ms]')
ylabel('U_{loop} [V]')
saveas(gcf, 'plot', 'jpg');
exit;
```

# Gnuplot

```
identifier = 'U_loop.csv' ;
ShotNo = '39187'
# Create a path to the data
DAS='Diagnostics/BasicDiagnostics/Results/'
baseURL='http://golem.fjfi.cvut.cz/shots/'
DataURL= baseURL.ShotNo.'/'.DAS.identifier
set datafile separator ',';
set title "Uloop for #".ShotNo;
! wget -q @DataURL ;# Write data from GOLEM erver to a local file
# Plot the graph from a local file
set xrange [0:0.02];set xlabel 'Time [s]';set ylabel 'U_1 [V]'
set terminal jpeg; plot identifier u 1:2 w l t 'Uloop'
```

```
shot_no=39187;\
signal_id="Diagnostics/BasicDiagnostics/Results/U_loop.csv";\
gnuplot -p -e "set title \"Golem\";set datafile separator \"\",\"\";\
set xlabel \"t [s]\";set ylabel \"U\";\
plot \"< \
wget -q -O - http://golem.fjfi.cvut.cz/shots/$shot_no/$signal_id\" \
w l t \"U\""
```

# GNU Wget

GNU Wget is a free software package for retrieving files using HTTP, HTTPS and FTP, the most widely-used Internet protocols. It is a non-interactive commandline tool, so it may easily be called from scripts, cron jobs, terminals without X-Windows support, etc.

- Runs on most UNIX-like operating systems as well as Microsoft Windows.
- Homepage: <http://www.gnu.org/software/wget/>
- Basic usage:
  - To get  $U_l$ : `wget http://golem.fjfi.cvut.cz/utis/data/<#ShotNo>/loop_voltage`
  - To get whole shot: `wget -r -nH -cut-dirs=3 -no-parent -l2 -Pshot http://golem.fjfi.cvut.cz/shots/<#ShotNo>`

# Excel

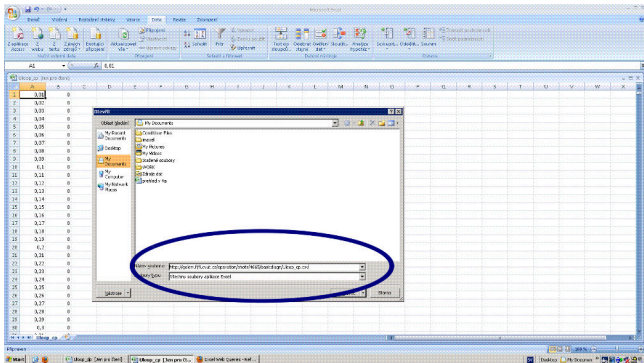

File→Open→

`http://golem.fjfi.cvut.cz/utils/data/<#ShotNo>/<identifier>`

Spreadsheets (Excel and others)

are not recommended, only tolerated.

# Table of Contents

- 1 Introduction
- 2 The Tokamak (GOLEM)
- 3 The Tokamak GOLEM (remote) operation
- 4 Conclusion**
- 5 Appendix

# The global schematic overview of the tokamak GOLEM experiment

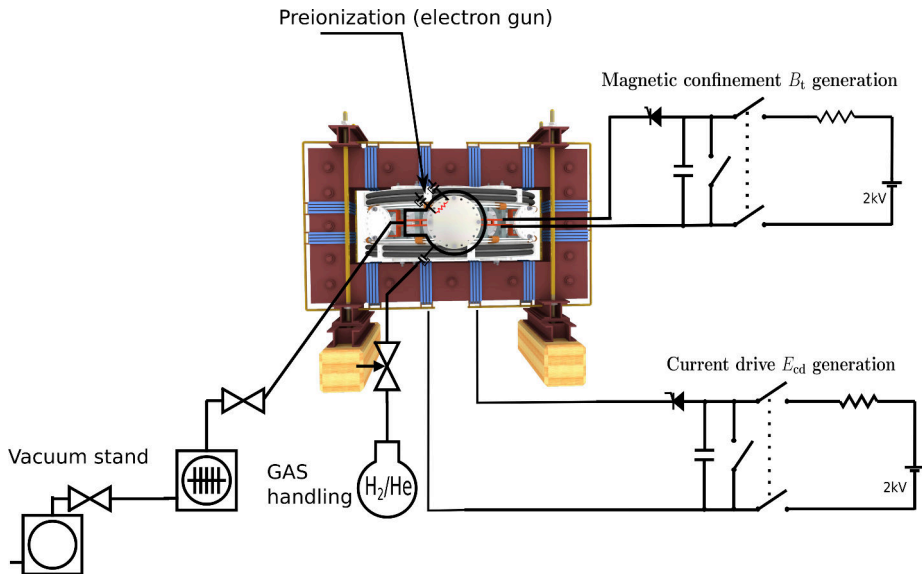

- Everything via `http://golem.fjfi.cvut.cz/UPP`
  - This presentation
  - Control rooms
  - Contact: Vojtech Svoboda,  
+420 737673903,  
vojtech.svoboda@fjfi.cvut.cz
  - Videoconference:  
`https://meet.google.com/hnv-qjhu-xvi`

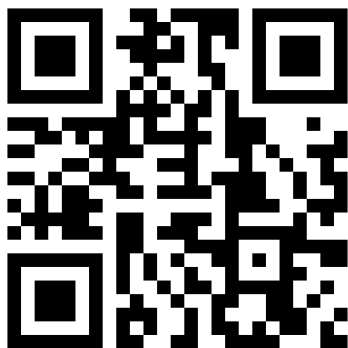





# Acknowledgement

## Financial support highly appreciated:

CTU RVO68407700, SGS 17/138/OHK4/2T/14, GAČR GA18-02482S, EU funds CZ.02.1.01/0.0/0.0/16\_019/0000778 and CZ.02.2.69/0.0/0.0/16\_027/0008465, IAEA F13019, FUSENET and EUROFUSION.

## Students, teachers, technicians (random order):

Vladimír Fuchs, Ondřej Grover, Jindřich Kocman, Tomáš Markovič, Michal Odstrčil, Tomáš Odstrčil, Gergo Pokol, Igor Jex, Gabriel Vondrášek, František Žáček, Lukáš Matěna, Jan Stockel, Jan Mlynář, Jaroslav Krbec, Radan Salomonovič, Vladimír Linhart, Kateřina Jiráková, Ondřej Ficker, Pravesh Dhyani, Juan Ignacio Monge-Colepicolo, Jaroslav Čerovský, Bořek Leitl, Martin Himmel. Petr Švihra, Petr Mácha, Vojtěch Fišer, Filip Papoušek, Sergei Kulkov, Martin Imříšek.

# Thank you for your attention

**Tokamak TM1**  
@Kurchatov Institute near Moscow  
~1960-1977

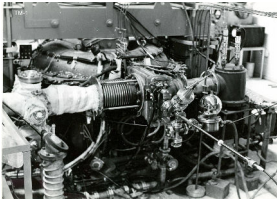

**SCIENCE**

**Tokamak CASTOR**  
@Institute of Plasma Physics, Prague  
1977-2007



**SCIENCE**  
& education

**Tokamak GOLEM**  
@Czech Technical University, Prague  
2007-

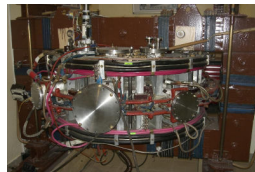

**EDUCATION**  
& science

... with the biggest  
control room  
in the world ..

**Tokamak Golem **\*\*REMOTE\*\*** for MASTER (Level 1)**  
The smallest & oldest operational tokamak with the biggest control rooms in the world

Home	Wiki	Control Room	Queue	Live	Results	GOLEM Diagram	Chamber status	IP cameras	3D model	Chat	Feedback	Stop
------	------	--------------	-------	------	---------	---------------	----------------	------------	----------	------	----------	------





**LEVEL 1**

Preionization (electron gun)  
Proton  
Toroidal magnetic field  
Current drive  
Vacuum island  
GAS handling  
Working Gas  
Discharge comment  
Place the discharge setup into the queue.



# Table of Contents

- 1 Introduction
- 2 The Tokamak (GOLEM)
- 3 The Tokamak GOLEM (remote) operation
- 4 Conclusion
- 5 Appendix**

# References I

-  Wikipedia contributors. Golem — Wikipedia, the free encyclopedia. <https://en.wikipedia.org/w/index.php?title=Golem>, 2020. [Online; accessed 29-March-2020].
-  Brotankova, J. *Study of high temperature plasma in tokamak-like experimental devices*. PhD thesis, 2009.
-  Tokamak GOLEM contributors. Tokamak GOLEM at the Czech Technical University in Prague. <http://golem.fjfi.cvut.cz>, 2007. [Online; accessed March 11, 2025].
-  J. Wesson. *Tokamaks*, volume 118 of *International Series of Monographs on Physics*. Oxford University Press Inc., New York, Third Edition, 2004.

## References II

-  **Wikipedia contributors.** Lawson criterion — Wikipedia, the free encyclopedia. [https://en.wikipedia.org/w/index.php?title=Lawson\\_criterion&oldid=888000448](https://en.wikipedia.org/w/index.php?title=Lawson_criterion&oldid=888000448), 2019. [Online; accessed 6-December-2019].
-  **ITER contributors .** ITER. <https://www.iter.org>, 2007. [Online; accessed 21-December-2018].

# Table of Contents

1 Introduction

2 The Tokamak (GOLEM)

3 The Tokamak GOLEM (remote) operation

4 Conclusion

**5 Appendix**

- The Electron energy confinement time calculation (rough estimation)
- A small note on magnetic measurements
- Few moments from the tokamak GOLEM history

# Towards ... Energy confinement time

## House

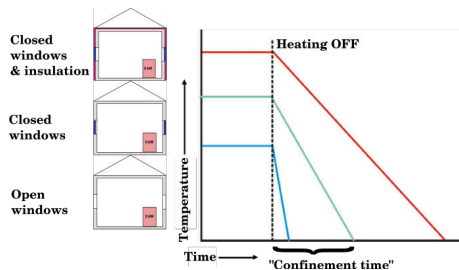

## Tokamak

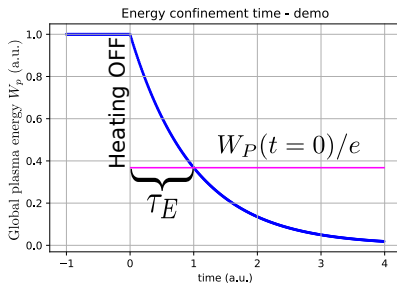

- Net power = Efficiency  $\times$  (Fusion - Radiation loss - Conduction loss)
- The confinement time:  $\tau_E = \frac{W}{P_{\text{loss}}}$
- Energy density  $W = 3nk_B T$  & rate of radiation and conduction energy loss per unit volume  $P_{\text{loss}}$
- Reactions per volume per time of fusion reactions is:  
 $f = n_d n_t \langle \sigma v \rangle = \frac{1}{4} n^2 \langle \sigma v \rangle$
- Fusion heating  $fE_{\text{ch}}$ , where  $E_{\text{ch}} = 3.5 \text{ MeV}$  should exceed the losses:  
 $fE_{\text{ch}} \geq P_{\text{loss}}$

$$n\tau_E \geq L \equiv \frac{12}{E_{\text{ch}}} \frac{k_B T}{\langle \sigma v \rangle} \geq 1.5 \cdot 10^{20} \frac{\text{s}}{\text{m}^3}$$

(DT reaction @ minimum  $\approx 26 \text{ keV}$ )



# The competition

The ITER: 3.6 s

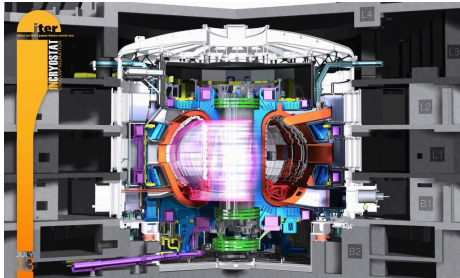

credit:[6]

The GOLEM: ??? s or ms or us ??

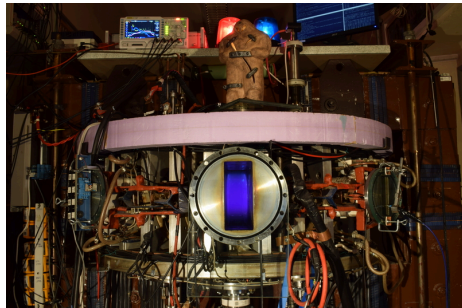

credit:[3]

## Energy confinement time

Under the assumption of a simplified power balance, the heating power  $P_H$  is partially absorbed in the plasma and leads to an increase of the plasma energy  $W_p$  and the rest is lost as the loss power  $P_{Loss}$

$$P_H = \frac{dW_p}{dt} + P_{Loss}$$

The energy confinement time is defined as the characteristic time scale of the exponential decay of the plasma energy  $W_p$  due to the loss power  $P_{Loss}$ :

$$\tau_E = \frac{W_p}{P_{Loss}} = \frac{W_p}{P_H - dW_p/dt}$$

Choosing the quasistationary phase of the plasma discharge, where  $\frac{dW_p}{dt} = 0$  gives:

$$\tau_E(t) = \frac{W_p(t)}{P_H(t)}$$

# The discharge - quasistationary phase

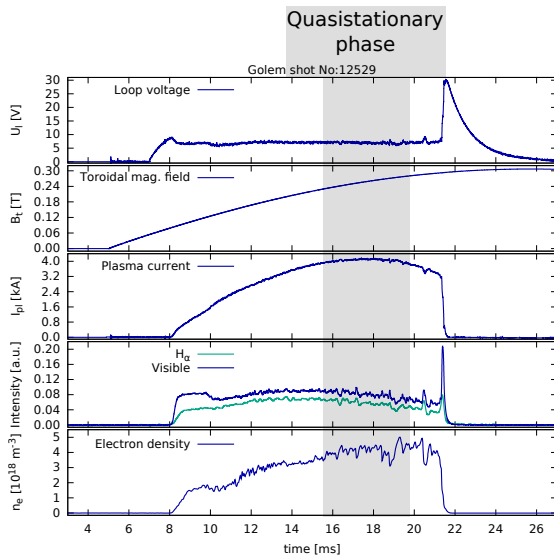

## Plasma heating power

On the GOLEM tokamak the only heating mechanism of the plasma is ohmic heating  $P_{OH}$  resulting from the plasma current  $I_p$  flowing in a conductor with finite resistivity  $R_p$ . The time dependence of the ohmic heating power can be calculated as:

$$P_H(t) = P_{OH}(t) = R_p(t) \cdot I_p^2(t)$$

# Plasma Energy

The global plasma energy content  $W_p$  can be simply calculated from the temperature estimation  $T_e(0, t)$ , average density  $n_e$  and plasma volume  $V_p$ , based on the ideal gas law, taking into account the assumed

$T_e(r, t) = T_e(0, t) \left(1 - \frac{r^2}{a^2}\right)^2$  temperature profile:

$$W_p(t) = V_p \frac{n_e k_B T_e(0, t)}{3}.$$

The information that the magnetic field reduces the degrees of freedom of the particles to two has been used to derive this formula.

- $V_p \approx 80 \text{ l}$

# Central Electron Temperature estimation (Spitzer Formula)

The time evolution of the central electron temperature  $T_e(0, t)$  is calculated from equation based on Spitzer's resistivity formula (see eg. [2],[4]):

$$T_e(0, t) = \left( \frac{R_0}{a^2} \frac{8Z_{eff.}}{1544} \frac{1}{R_p(t)} \right)^{2/3}, [eV; m, \Omega]$$

For particular case of the GOLEM tokamak it says:

$$T_e(0, t) = 0.9 \cdot \left( \frac{I_p(t)}{U_I(t)} \right)^{2/3}, [eV; A, V]$$

# Towards Electron energy confinement time $\tau_{eE}$

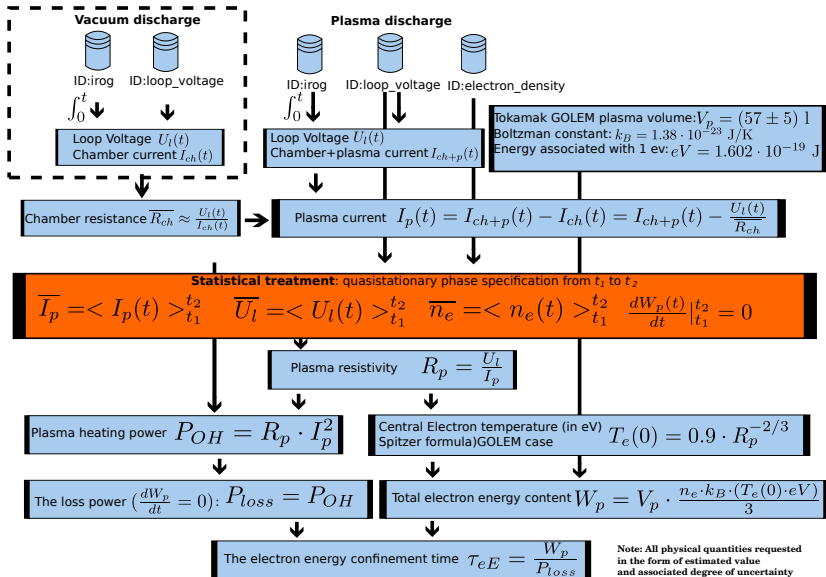

# The GOLEM tokamak - standard diagnostics

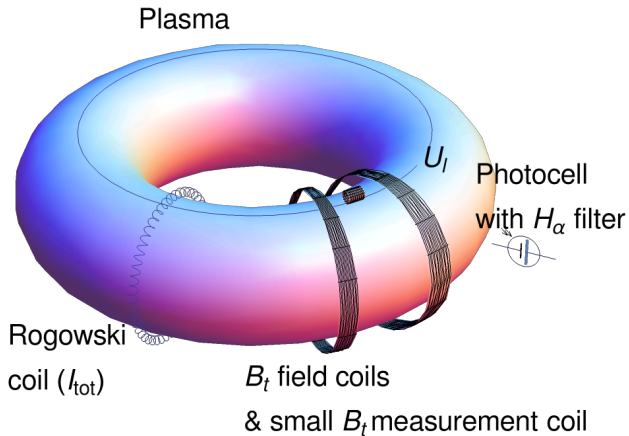



# Hands on the GOLEM tokamak - equipment



# The GOLEM tokamak interferometry HW

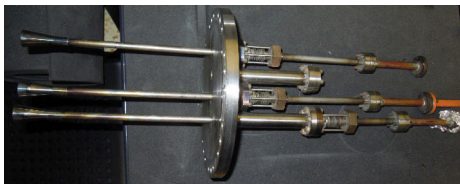

# Vacuum x Plasma discharge @ Oscilloscope

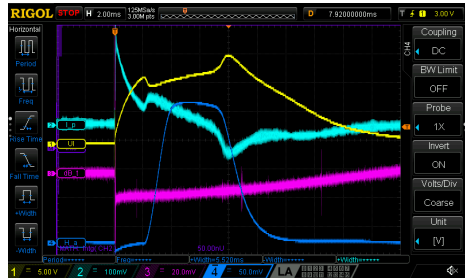
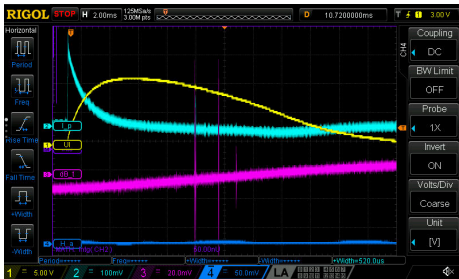

# Vacuum x Plasma shot

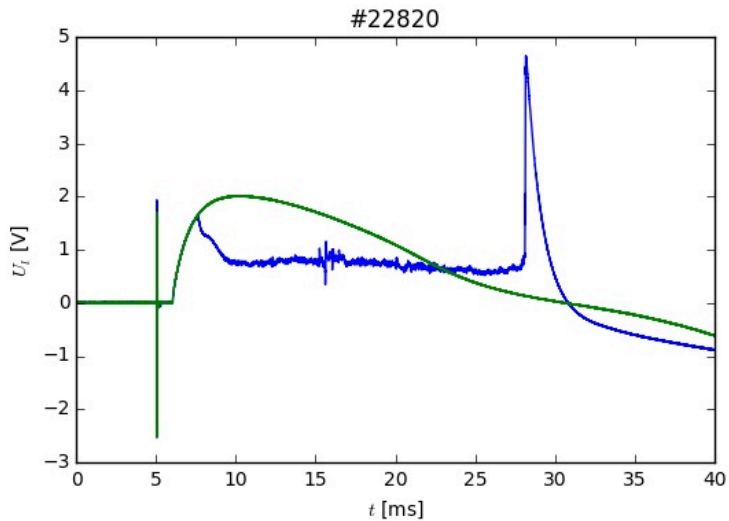

# Table of Contents

1 Introduction

2 The Tokamak (GOLEM)

3 The Tokamak GOLEM (remote) operation

4 Conclusion

**5 Appendix**

- The Electron energy confinement time calculation (rough estimation)
- A small note on magnetic measurements
- Few moments from the tokamak GOLEM history

# Schematic of electromagnetic diagnostics

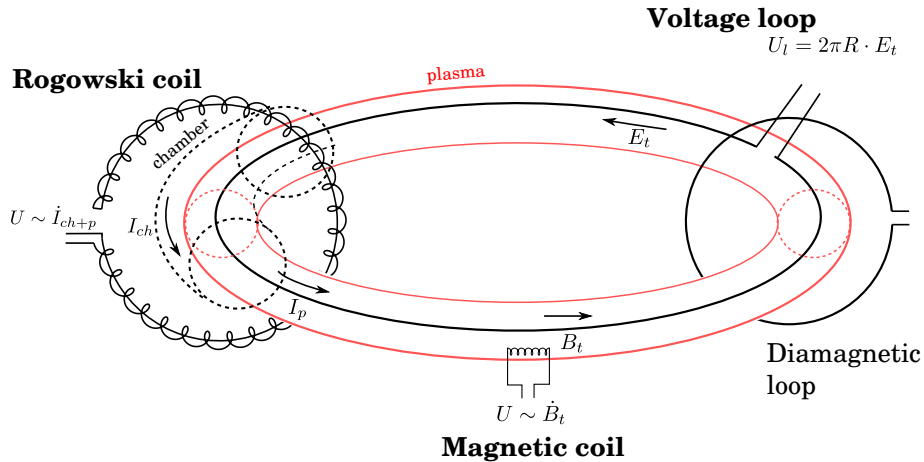

# Rogowski coil for the (chamber & plasma) current $I_{ch+p}$ measurements

## Rogowski coil

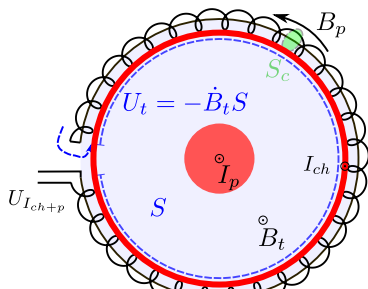
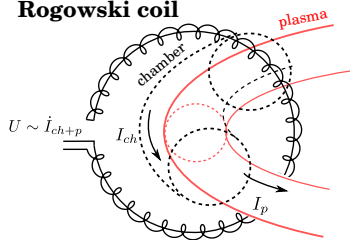

- Ampere's Law:  $\nabla \times \mathbf{B} = \mu_0 \mathbf{j}$   
(neglecting  $\dot{\mathbf{D}}$ )
- current through (const) surface  $S$ :  
 $\int \mathbf{j} \cdot d\mathbf{S} = I_{ch+p}$
- (const) poloidal field along surface border  $l$ :  $\int \nabla \times \mathbf{B} \cdot d\mathbf{S} = \oint B_p dl = I B_p$
- voltage induced:  $U_{I_{ch+p}} + U_t - U_t = -N \dot{B}_p S_c = -\mu_0 \frac{N S_c}{l} \dot{I}_{ch+p}$
- The wire of the coil is back-wound to omit a strong toroidal magnetic field  $B_t$  signal.

# Magnetic measurements generally I

- Raw signals (analog  $U_r(t)$  or, respectively, it's discretized digital  $U_i$  counterpart form ) must be specially maintained:
  - corrected for the DC bias  $U_{offset}$  of the measurement circuit,
  - integrated (pure diagnostics signal voltage  $U_d(t)$  is induced by the time derivative of the appropriate magnetic flux),
  - multiplied by calibration factors  $C_d$  ( $C_{Bt}$ ,  $C_{RC}$ ).
- We can express the basic relationship  $U_r(t) = U_d(t) + U_{offset}$
- The measured signal  $U_d(t)$  is proportional to the time derivative of the original physical quantity  $D(t)$  signal (it is a magnetic measurement):

$$U_d(t) \propto \frac{dD(t)}{dt}, \text{ or } U_d(t) = C_d \frac{dD(t)}{dt}$$

Where the linearity coefficient  $C_d$  is called a calibration factor.



## Magnetic measurements generally II

- To determine the desired physical quantity  $D(t)$ , we just have to perform an integration over time:

$$D(t) = \frac{1}{C_d} \int_0^t U_d(t') dt' = \frac{1}{C_d} \int_0^t (U_r(t) - U_{offset}) dt'$$

- In reality, the measurement is not continuous. The system performs a series of measurements  $U_i$  separated by with time step  $\Delta t = 1 \text{ us}$ .
- In practice, we replace the integral by a sum:

$$D_i = \frac{1}{C_d} \sum_{j=0}^{t/\Delta t} (U_i(t_j) - U_{offset}) \Delta t$$
$$D_i = \frac{1}{C_d} \left( \sum_{j=0}^{t/\Delta t} U_i(t_j) \right) - U_{offset} t$$

- The offset  $U_{offset}$  can be specified from the beginning of the data series before switching on the real experiment.

# Magnetic measurement demo - game with $U_{offset}$

Without  $U_{offset}$

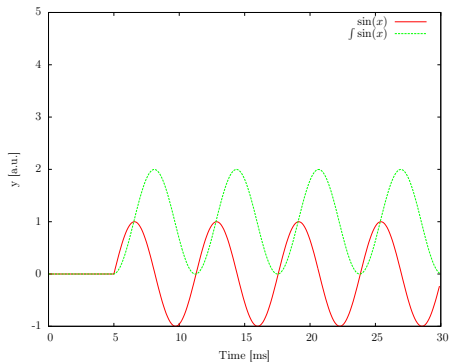

With  $U_{offset}$

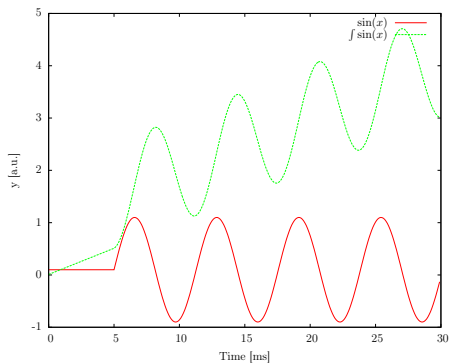

# Table of Contents

1 Introduction

2 The Tokamak (GOLEM)

3 The Tokamak GOLEM (remote) operation

4 Conclusion

**5 Appendix**

- The Electron energy confinement time calculation (rough estimation)
- A small note on magnetic measurements
- Few moments from the tokamak GOLEM history

XX/YY: TM-1

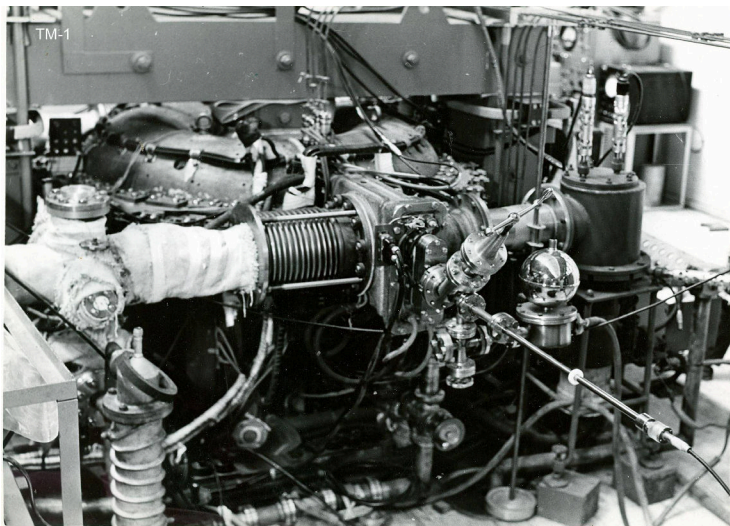

# XX/YY: CASTOR

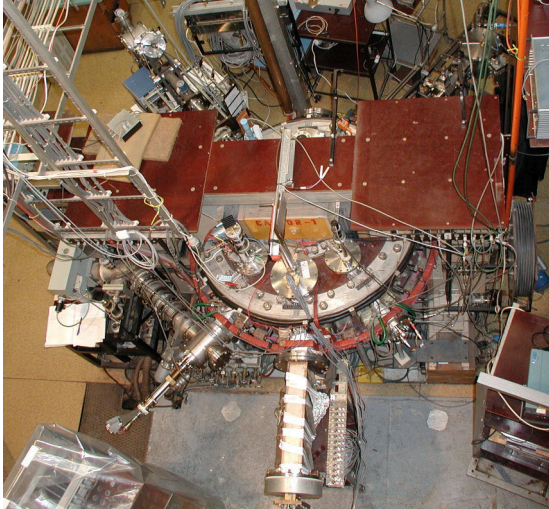

# 12/07: Last minutes at the IPP Prague

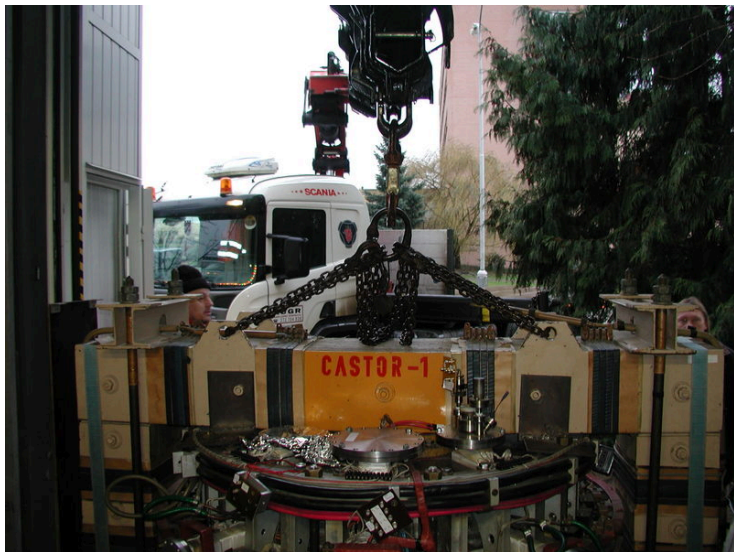

# 12/07: First minutes at the CTU Prague



# 07/09: First plasma in the tokamak GOLEM

Časové průběhy signálů zřetelně ukazují, že došlo k průrazu neutrálního plynu a k zformování plazmatu.

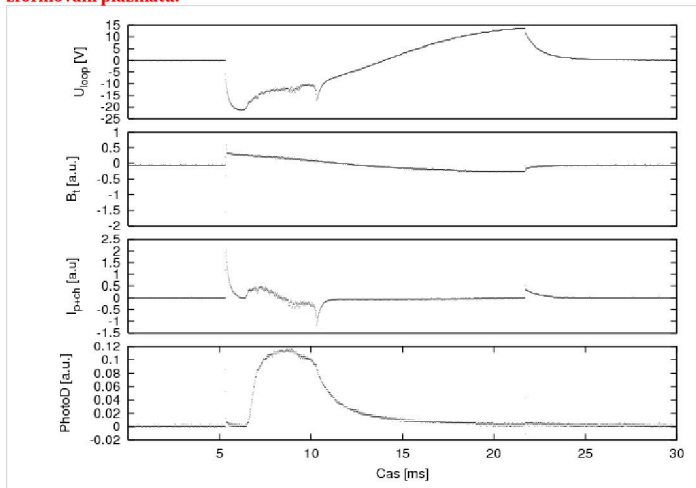

O tom svědčí:

1. Rychlý pokles napětí na závit v čase  $t = 6-7$  ms a jeho malé fluktuační, které lze vidět až



# 09/09: Tokamak and tokamak



# 11/11: NP laureat at tokamak GOLEM

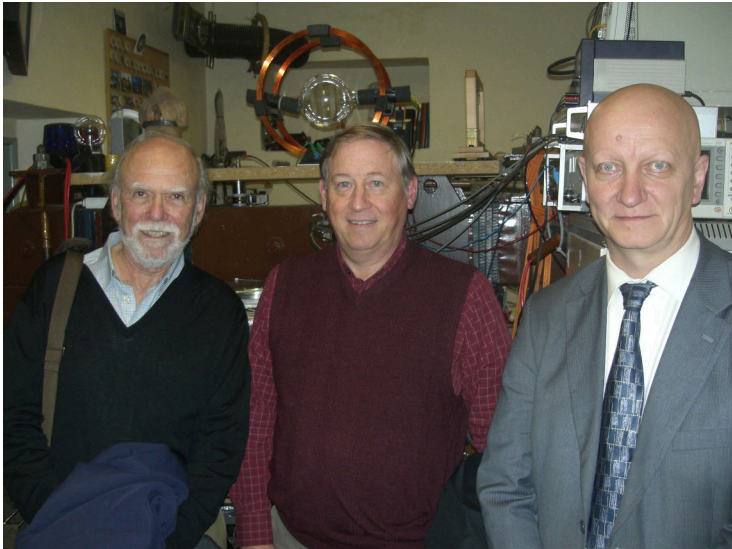

05/16: The youngest tokamak (GOLEM) operator, Adam (7 years).



# 0916: ITER DG, Mr. Bernard Bigot (Shot #22185)

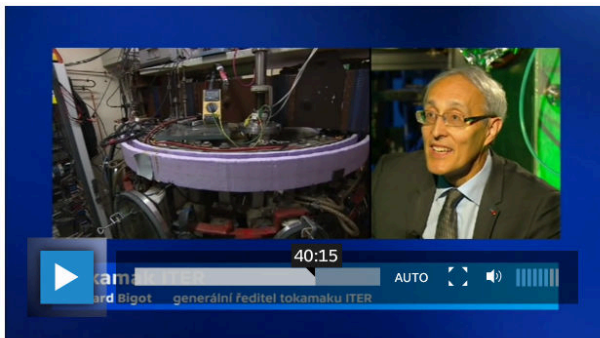

Quotation from Czech Television Hydepark

*I am very pleased with the GOLEM ...*

# 09/19 Paper model ABC

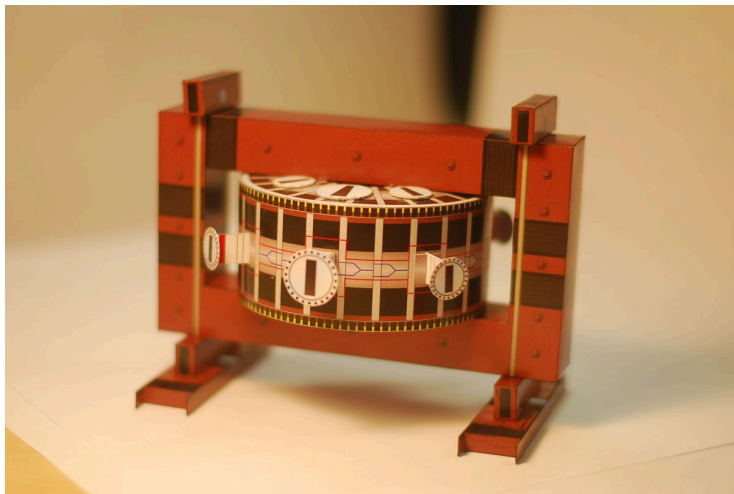

## 2010: Tokamak GOLEM



# 2011: The tokamak COMPASS with NBI



# 2016: ITER segment





## 2017: First Spitzer Stellarator



# 10/15: Trojan horse - #20000

GOLEM - Shot #20000 - previous | next | current

## Tokamak GOLEM - Shot Database - 20000

Date: 2015-10-22 - 16:09:25  
Session: SessionPreparation  
Comment: 20k

[Template source]  
[WebLog]

**Diagnostics**

- ✓ PlasmaPosition\_TO
- ✗ Filers
- ✗ Spectrometer
- ✓ FastCamera
- ✓ HXR

**Analysis**

- ✓ HistoricalAnalysis
- ✓ ShotHomepage
- ✓ AdvancedAnalysis
- ✓ Spectrogramm\_TO
- ✗ MultiCWT\_TO
- ✓ MWPreparation
- ✗ Inquiries\_TO

**DAS**

- ✓ TektronixCPO
- ✓ Pappouch\_3
- ✓ Notstandard
- ✓ Pappouch\_Za
- ✓ Pappouch\_Sl

**Vacuum log**

Charging log

**Other**

Data  
References  
About  
Wiki  
Utilities

**Navigation**

Next  
Previous  
Current

**Go to shot**  
20000

**Congratulation, you have reached nuclear fusion.**  
**The following explosion destroyed half of Prague and radioactive fallout contaminated whole Europe.**  
**Have a nice day**



**Basic parameters:** (compare)

- Gas pressure  $p_{D,20}$ : 10.28 -> 15.38 mPa (request: 5 mPa) <sup>Wiki</sup>
- Working gas: H
- Preionization: Upper el. gun
- Chamber temperature: 20.00 C
- $C_{B1}$  capacitors charged to: 1000 V, triggered 5:0.85 <sup>Wiki</sup>
- $C_{B2}$  capacitors charged to: 0 V, triggered 5:0.85 <sup>Wiki</sup>
- $C_{C2}$  capacitors charged to: 500 V, triggered 6:0.85 <sup>Wiki</sup>
- $C_{S1}$  capacitors charged to: 0 V, triggered 5:0.85 <sup>Wiki</sup>
- Probability of breakdown: N/A <sup>Wiki</sup>
- Time since session beginning: 0:19:25 h

**Plasma parameters:**

- Plasma life time 8.7 [ms] (from 7.5 to 16.2) <sup>Wiki</sup>
- Mean toroidal magnetic field Bt: 0.22 T <sup>Wiki</sup>
- Mean plasma current: 1.42 kA <sup>Wiki</sup>
- Mean Uloop: 12.41 V <sup>Wiki</sup>
- Break down voltage: 10.5 V <sup>Wiki</sup>
- Ohmic heating power: 17.59 kW
- Q edge: 6.9 <sup>Wiki</sup>
- Electron temperature: 13.5 eV <sup>Wiki</sup>
- Line electron density: N/A [ $10^{17} \text{m}^{-2}$ ] <sup>Wiki</sup>

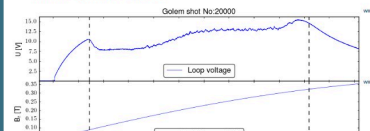

11/17: GOLEM tokamak "mapping"

# Tokamak GOLEM

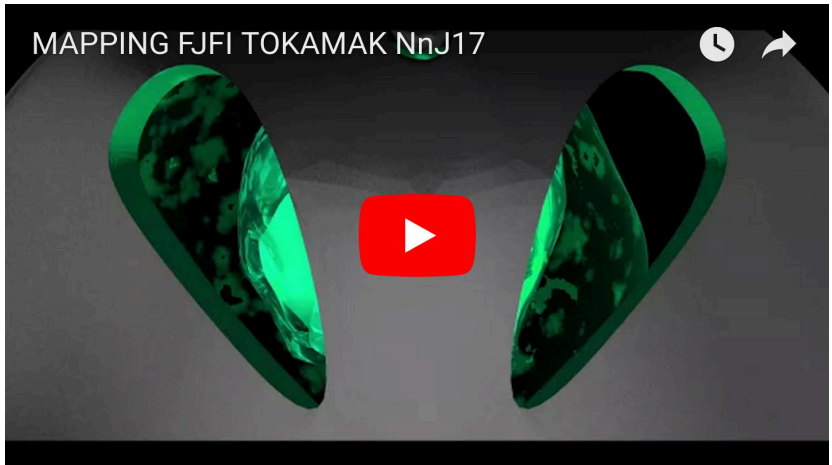

# Základní (řádová) statistika k 30.11.2012

Počet dní od instalace: 1815.

Počet operačních dní:  $\approx 438$ .

Počet hodin:  $\approx 1954$

Počet shotů: 10417.

Počet shotů –  $>$  plazma:  $\approx 7600$ .

Průměrná délka výboje:  $\approx 7$  ms.

**Celková délka trvání plazmatu:  $< 60$  s.**