

Introduction to the tokamak GOLEM operation Practical guide

Vojtěch Svoboda
on behalf of the tokamak GOLEM team
for the Torino Politecnico, Italy

November 11, 2024

Table of Contents

- 1 Introduction
- 2 The Tokamak (GOLEM)
- 3 The Tokamak GOLEM (remote) operation
- 4 Conclusion
- 5 Appendix

Milestones to Fusion Power Plant

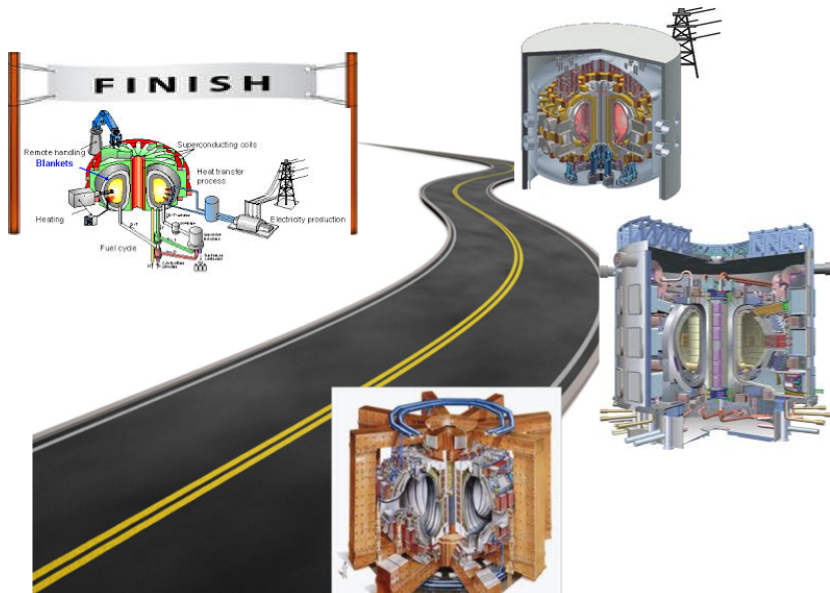

Education importance

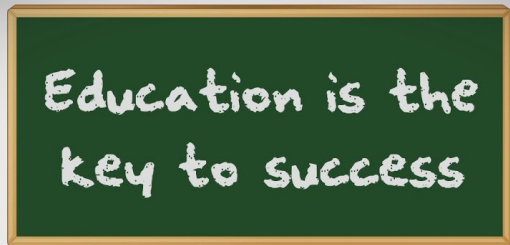

Let's start with the tokamak GOLEM - *the smallest tokamak in the World with the biggest control room*

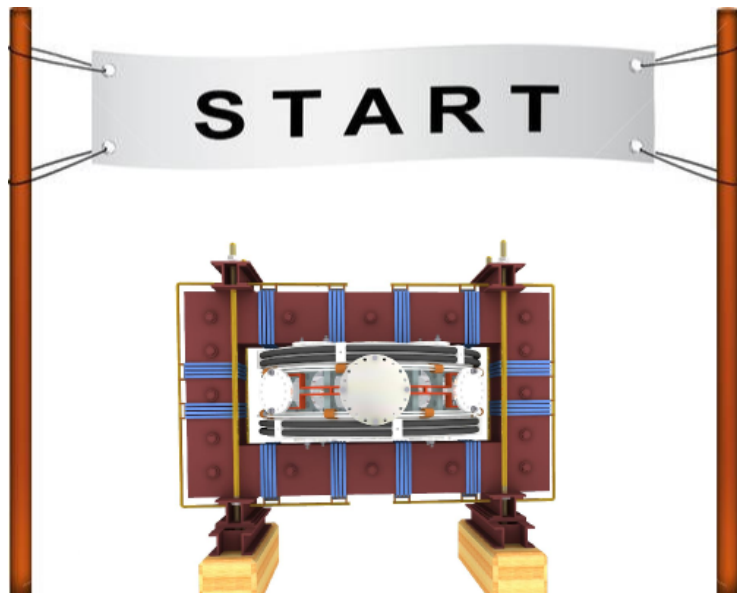

The GOLEM tokamak basic characteristics

The grandfather of all tokamaks (ITER newslines 06/18)

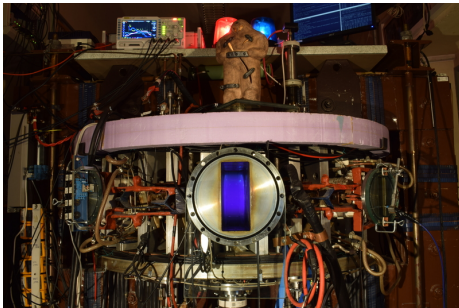

- Vessel major radius: $R_0 = 0.4$ m
- Vessel minor radius: $r_0 = 0.1$ m
- Maximum plasma current:
 $I_p^{\max} < 8$ kA
- Maximum toroidal magnetic field: $B_t^{\max} < 0.5$ T
- Typical electron density:
 $\langle n_e \rangle \in (0.2, 3) \cdot 10^{19} \text{ m}^{-3}$
- Maximum electron temperature:
 $T_e^{\max} < 80$ eV
- Maximum discharge duration:
 $\tau_p^{\max} < 25$ ms

Tokamak GOLEM @ Wikipedia ..

File Edit View Go Bookmarks Tools Settings Window Help

W https://en.wikipedia.org/wiki/Tokamak

home Kalendarj Produkce Forecast Slovník Itano

Not logged in Talk Contributions Create account Log in

Article Talk Read Edit View history Search

 WIKIPEDIA
The Free Encyclopedia

Main page
Contents
Featured content
Current events

Tokamak

From Wikipedia, the free encyclopedia

This article is about the fusion reaction device. For other uses, see [Tokamak \(disambiguation\)](#).

A **tokamak** (Russian: **токамак**) is a device that uses a powerful magnetic field to confine plasma in the shape of a torus. Achieving a stable plasma equilibrium requires magnetic field lines that curve around the torus in a helical shape. Such a helical field can be generated by adding a toroidal field

it decays into a proton and electron with the emission of energy. When the time comes to actually try to make electricity from a tokamak-based reactor, some of the neutrons produced in the fusion process would be absorbed by a liquid metal blanket and their kinetic energy would be used in heat-transfer processes to ultimately turn a generator.

Experimental tokamaks [edit]

Currently in operation [edit]

(in chronological order of start of operations)

- 1960s: TM1-MH (since 1977 Castor; since 2007 Golem^[12]) in Prague, Czech Republic. In operation in Kurchatov Institute since early 1960s but renamed to Castor in 1977 and moved to IPP CAS,^[13] Prague; in 2007 moved to FNSPE, Czech Technical University in Prague and renamed to Golem.^[14]
- 1975: T-10, in Kurchatov Institute, Moscow, Russia (formerly Soviet Union); 2 MW
- 1983: Joint European Torus (JET), in Culham, United Kingdom
- 1985: JT-60, in Naka, Ibaraki Prefecture, Japan; (Currently undergoing upgrade to Super, Advanced model)
- 1987: STOR-M, University of Saskatchewan; Canada; first demonstration of alternating current in a tokamak.
- 1988: Tore Supra,^[15] at the CEA, Cadarache, France
- 1989: Aditya, at Institute for Plasma Research (IPR) in Gujarat, India
- 1980s: DIII-D,^[16] in San Diego, USA; operated by General Atomics since the late 1980s
- 1989: COMPASS,^[13] in Prague, Czech Republic; in operation since 2008, previously operated from 1989 to 1999 in Culham, United Kingdom
- 1990: FTU, in Frascati, Italy
- 1991: Tokamak ISTTOK,^[17] at the Instituto de Plasmas e Fusão Nuclear, Lisbon, Portugal;
- 1991: ASDEX Upgrade, in Garching, Germany



Alcator C-Mod



ida, the free encyclo... W Tokamak - Wikipedia, the free encyclo... [svoboda] buon@fi.cvut.cz - Kosside [Krusader] Inbox - svoboda@fi.cvut.cz - Mail

The GOLEM tokamak for education - historical background

Kurchatov Institute near Moscow,
Soviet Union
1960: **TM1-MH**

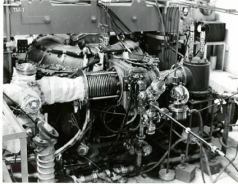

1974



Culham Centre for Fusion Energy
Great Britain
1989: **COMPASS-D**

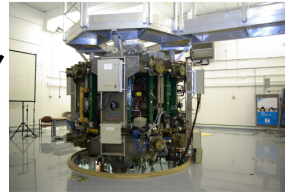

2006



Institute of Plasma Physics
Czech republic
CASTOR **COMPASS**



2008



Czech Technical University Prague
Czech republic
GOLEM



GOLEM

... somewhere, in the ancient cellars of Prague,

there is hidden indeed "infernal" power. Yet it is the very power of celestial stars themselves. Calmly dormant, awaiting mankind to discover the magic key, to use this power for their benefit...



At the end of the 16th century, in the times when the Czech lands were ruled by Emperor Rudolf II, in Prague, there were Rabbi Judah Loew, well known alchemist, thinker, scholar, writer and inventor of the legendary GOLEM - a clay creature inspired with the Universe power that pursued his master's command after being brought to life with a shem, . Golem is not perceived as a symbol of evil, but rather as a symbol of power which might be useful but is very challenging to handle. To learn more of the Golem legend, see e.g. [1].

The global schematic overview of the tokamak GOLEM experiment

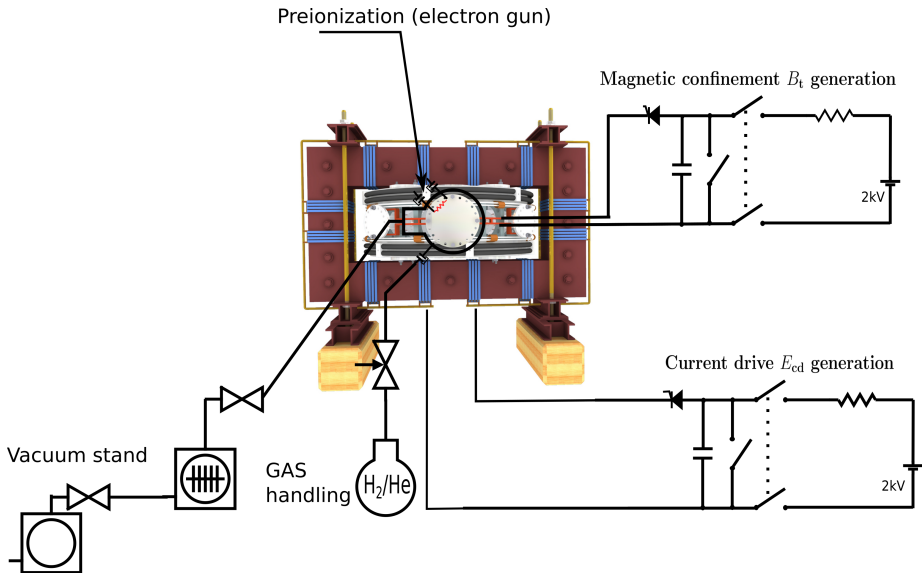

The GOLEM tokamak mission

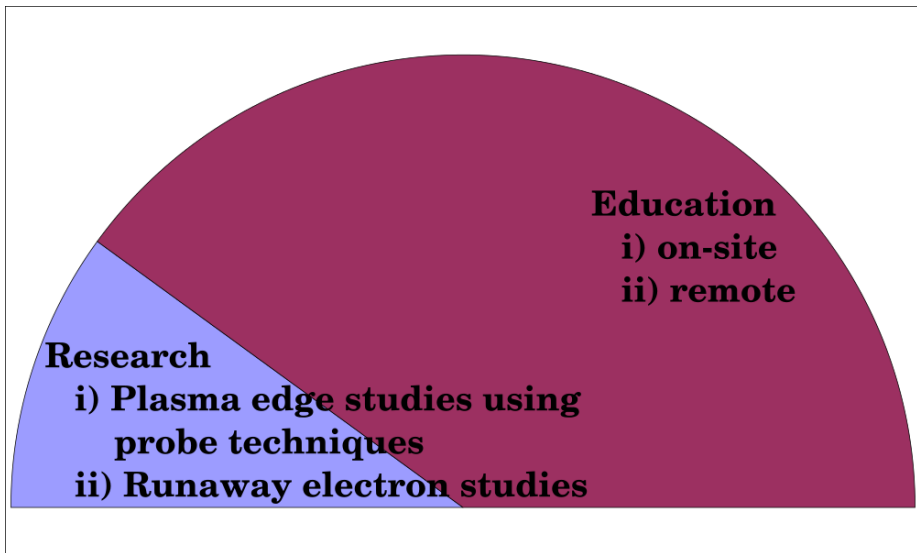

Production

- Everything via <http://golem.fjfi.cvut.cz/Torino>
 - This presentation
 - Control rooms
 - Contact: Vojtech Svoboda,
+420 737673903,
vojtech.svoboda@fjfi.cvut.cz
 - Videoconference:
<https://meet.google.com/hnv-qjhu-xvi>



Table of Contents

- 1 Introduction
- 2 The Tokamak (GOLEM)**
- 3 The Tokamak GOLEM (remote) operation
- 4 Conclusion
- 5 Appendix

Tokamak magnetic confinement concept

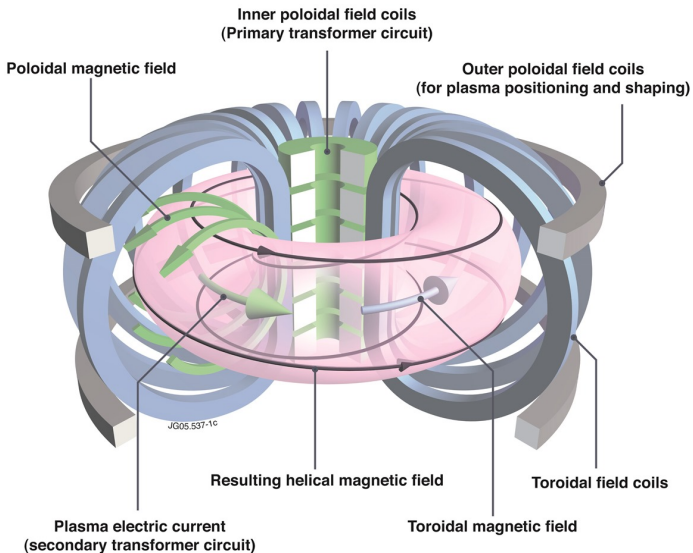

Tokamak (GOLEM) basic concept to confine and heat the plasma

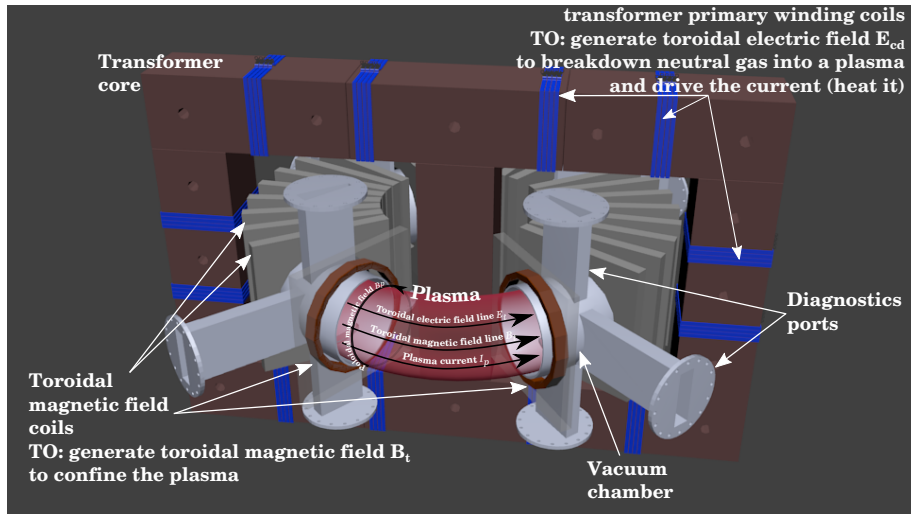

Table of Contents

1 Introduction

2 The Tokamak (GOLEM)

- The GOLEM tokamak concept
- The scenario to make the (GOLEM) tokamak discharge
- The scenario to discharge virtually
- The GOLEM tokamak - guide tour
- The GOLEM tokamak basic diagnostics

3 The Tokamak GOLEM (remote) operation

4 Conclusion

5 Appendix

Our goal: the technology to create a μ Sun on the Earth

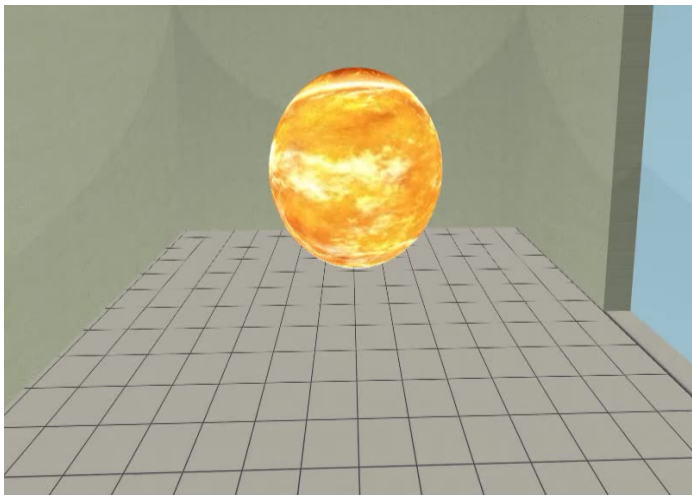

Magnetic confinement requires toroidal geometry

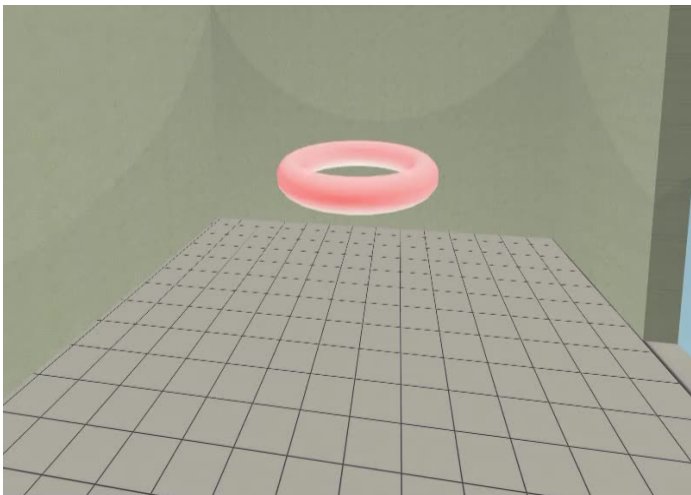

A chamber contains the thermonuclear reaction

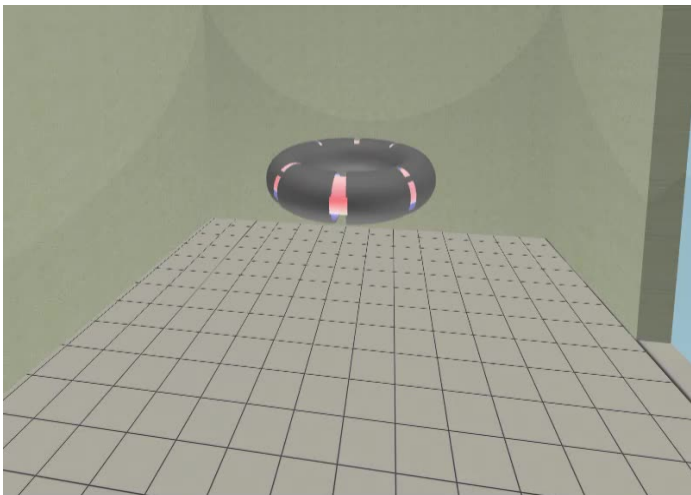

Toroidal magnetic field coils confine the plasma

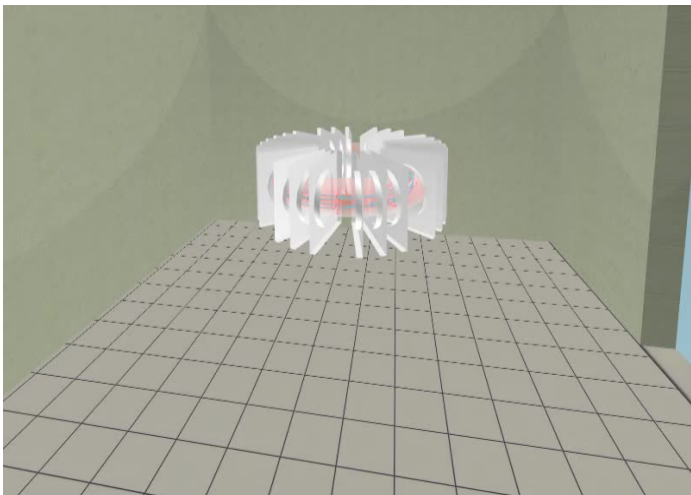

A transformer action creates and heats the plasma

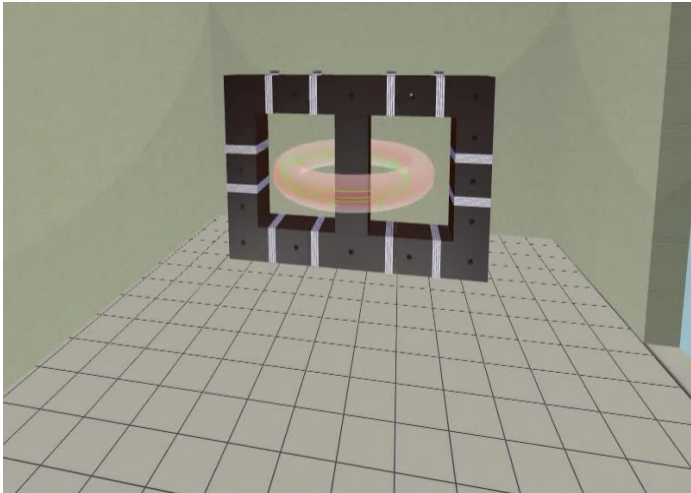

The final technology altogether

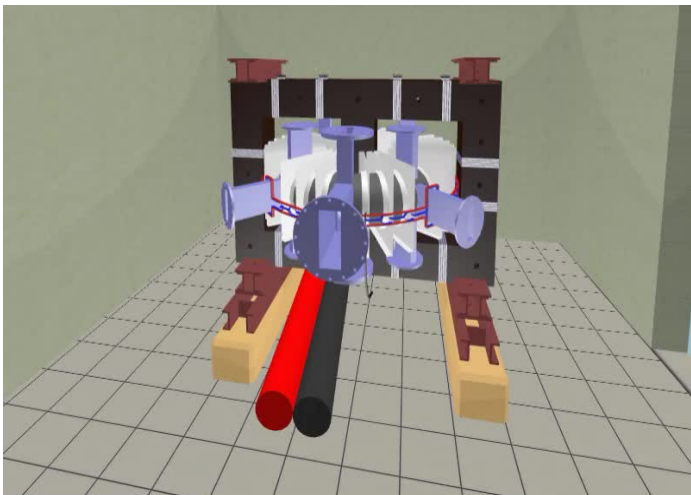

Table of Contents

1 Introduction

2 The Tokamak (GOLEM)

- The GOLEM tokamak concept
- The scenario to make the (GOLEM) tokamak discharge
- The scenario to discharge virtually
- The GOLEM tokamak - guide tour
- The GOLEM tokamak basic diagnostics

3 The Tokamak GOLEM (remote) operation

4 Conclusion

5 Appendix

Plasma in Tokamak (GOLEM) - the least to do

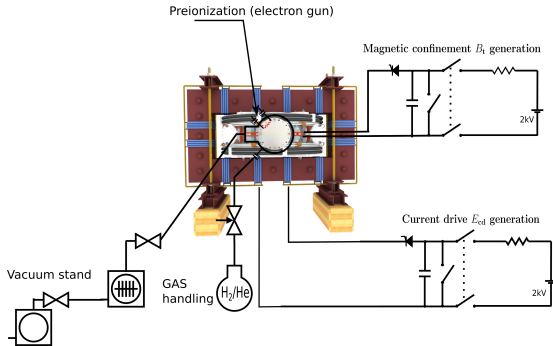

To do:

- session start phase:
 - Evacuate the chamber
- pre-discharge phase
 - Charge the capacitors
 - Fill in the working gas
 - Preionization
- discharge phase
 - Trigger Magnetic confinement & Current drive
 - Plasma positioning
 - Diagnostics
- post-discharge phase

Plasma in Tokamak (GOLEM) - the least to do

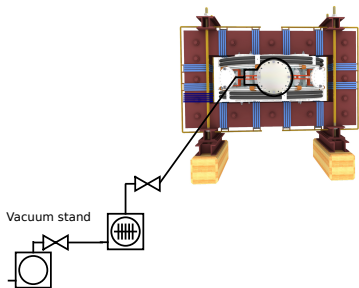

To do:

- session start phase:
 - **Evacuate the chamber**
- pre-discharge phase
 - Charge the capacitors
 - Fill in the working gas
 - Preionization
- discharge phase
 - Trigger Magnetic confinement & Current drive
 - Plasma positioning
 - Diagnostics
- post-discharge phase

Plasma in Tokamak (GOLEM) - the least to do

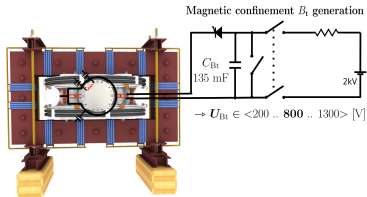

To do:

- session start phase:
 - Evacuate the chamber
- pre-discharge phase
 - **Charge the capacitors**
 - Fill in the working gas
 - Preionization
- discharge phase
 - Trigger Magnetic confinement & Current drive
 - Plasma positioning
 - Diagnostics
- post-discharge phase

Plasma in Tokamak (GOLEM) - the least to do

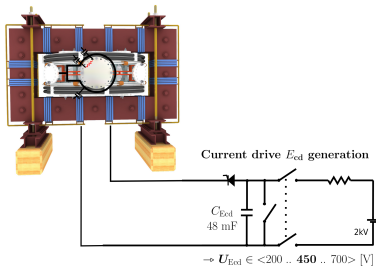

To do:

- session start phase:
 - Evacuate the chamber
- pre-discharge phase
 - **Charge the capacitors**
 - Fill in the working gas
 - Preionization
- discharge phase
 - Trigger Magnetic confinement & Current drive
 - Plasma positioning
 - Diagnostics
- post-discharge phase

Plasma in Tokamak (GOLEM) - the least to do

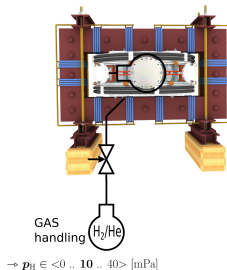

To do:

- session start phase:
 - Evacuate the chamber
- pre-discharge phase
 - Charge the capacitors
 - **Fill in the working gas**
 - Preionization
- discharge phase
 - Trigger Magnetic confinement & Current drive
 - Plasma positioning
 - Diagnostics
- post-discharge phase

Plasma in Tokamak (GOLEM) - the least to do

Preionization (electron gun)
→ $S/W_{\text{preion}} \in \langle \text{on} \dots \text{on} \dots \text{off} \rangle [-]$

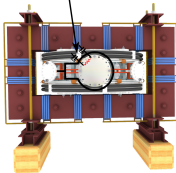

To do:

- session start phase:
 - Evacuate the chamber
- pre-discharge phase
 - Charge the capacitors
 - Fill in the working gas
 - **Preionization**
- discharge phase
 - Trigger Magnetic confinement & Current drive
 - Plasma positioning
 - Diagnostics
- post-discharge phase

Plasma in Tokamak (GOLEM) - the least to do

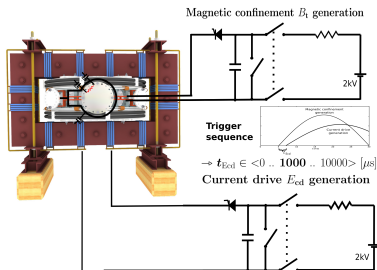

To do:

- session start phase:
 - Evacuate the chamber
- pre-discharge phase
 - Charge the capacitors
 - Fill in the working gas
 - Preionization
- discharge phase
 - **Trigger Magnetic confinement & Current drive**
 - Plasma positioning
 - Diagnostics
- post-discharge phase

Tokamak GOLEM - schematic experimental setup

Preionization (electron gun)

→ $S/W_{\text{preion}} \in \langle \text{on} \dots \text{on} \dots \text{off} \rangle [-]$

Magnetic confinement B_t generation

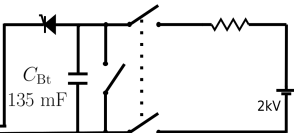

→ $U_{Bt} \in \langle 200 \dots 800 \dots 1300 \rangle [V]$

Trigger sequence

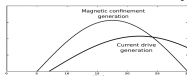

Current drive E_{cd} generation

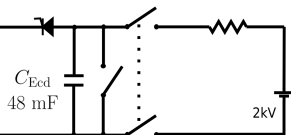

→ $U_{Ecd} \in \langle 200 \dots 450 \dots 700 \rangle [V]$

→ $t_{Ecd} \in \langle 0 \dots 1000 \dots 10000 \rangle [\mu s]$

Vacuum stand



GAS handling



→ $p_H \in \langle 0 \dots 10 \dots 40 \rangle [\text{mPa}]$

H_2/He

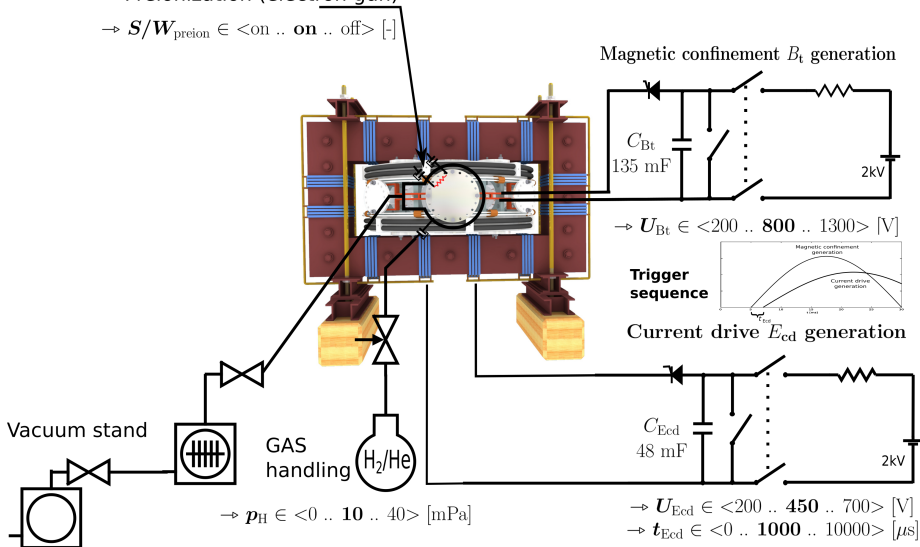

Remote control interface of the GOLEM tokamak

Introduction Working gas Preionization Magnetic field Electric field Submit

Set the pressure and type of the working gas from which the plasma is formed. Pressure must be high enough for plasma to form, but low enough for gas breakdown to occur.

Preionization (electron gun)

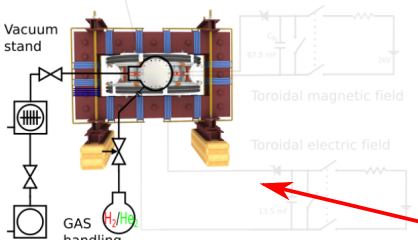

Vacuum stand

GAS handling H_2/He

Toroidal magnetic field

Toroidal electric field

Gas type and pressure $p_{WG} = 16 \text{ mPa}$

Hydrogen Helium

Next Set recommended value

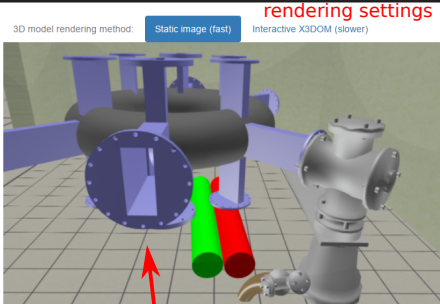

3D model rendering

engineering scheme

sliders and checkboxes

workflow buttons

Let's make a discharge

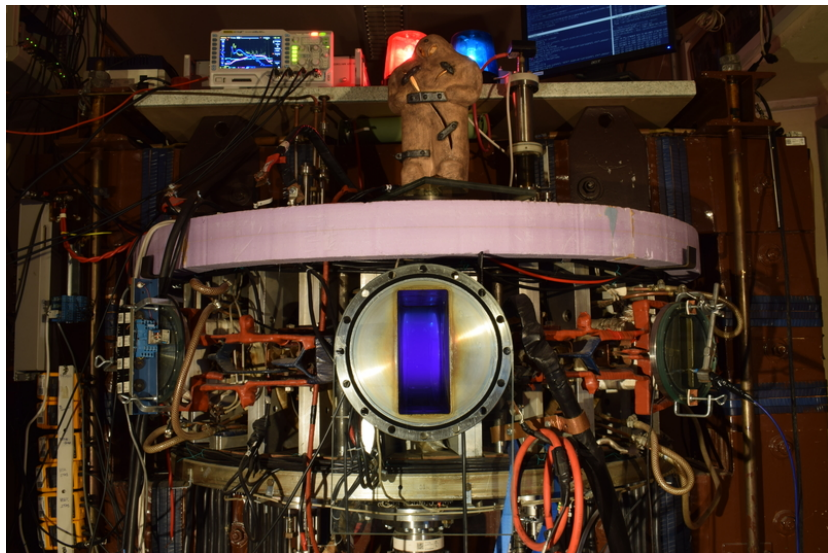

Table of Contents

1 Introduction

2 The Tokamak (GOLEM)

- The GOLEM tokamak concept
- The scenario to make the (GOLEM) tokamak discharge
- The scenario to discharge virtually
- The GOLEM tokamak - guide tour
- The GOLEM tokamak basic diagnostics

3 The Tokamak GOLEM (remote) operation

4 Conclusion

5 Appendix

Introduce the working gas (Hydrogen x Helium)

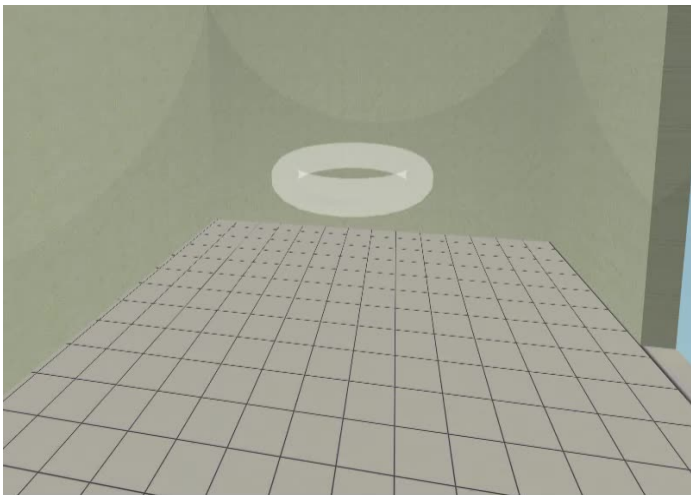

Switch on the preionization

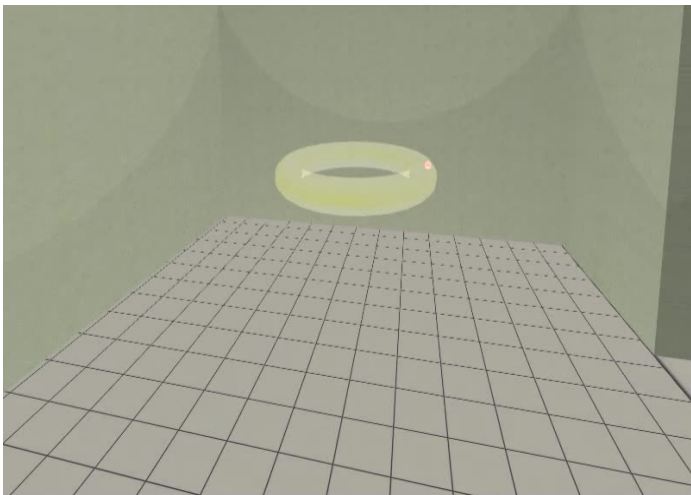

Introduce the magnetic field

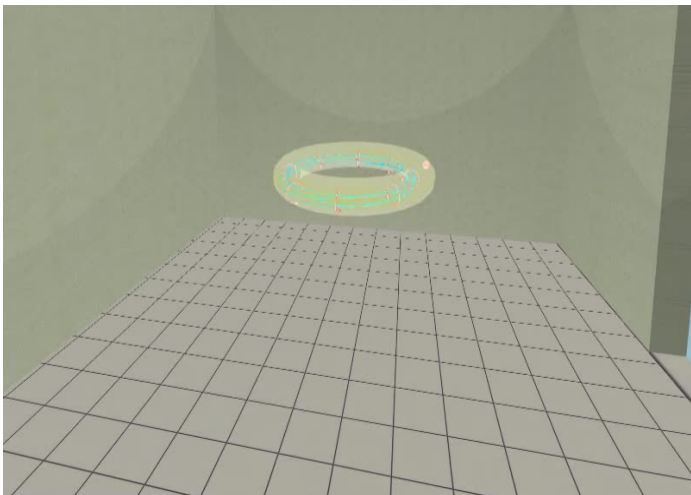

Introduce the electric field

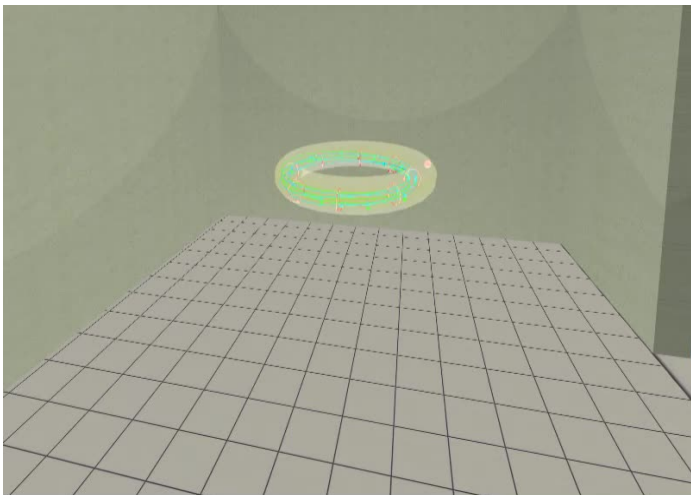

Plasma ..

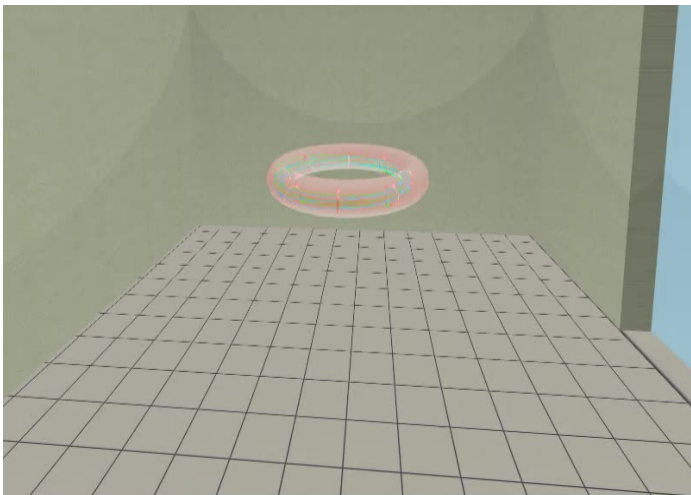

Table of Contents

1 Introduction

2 The Tokamak (GOLEM)

- The GOLEM tokamak concept
- The scenario to make the (GOLEM) tokamak discharge
- The scenario to discharge virtually
- The GOLEM tokamak - guide tour
- The GOLEM tokamak basic diagnostics

3 The Tokamak GOLEM (remote) operation

4 Conclusion

5 Appendix

Infrastructure room (below tokamak) 10/16



Infrastructure room (below tokamak) 10/16

Current drive CD field
and toroidal magnetic Bt field
circuits

To the tokamak
GOLEM

Rotary
pump

Vacuum
control

Current drive CD
capacitors

Plasma
stabilization

power
supply
2kV

Toroidal
magnetic field B
capacitors

fire
protection
system



Tokamak room (North) 10/16

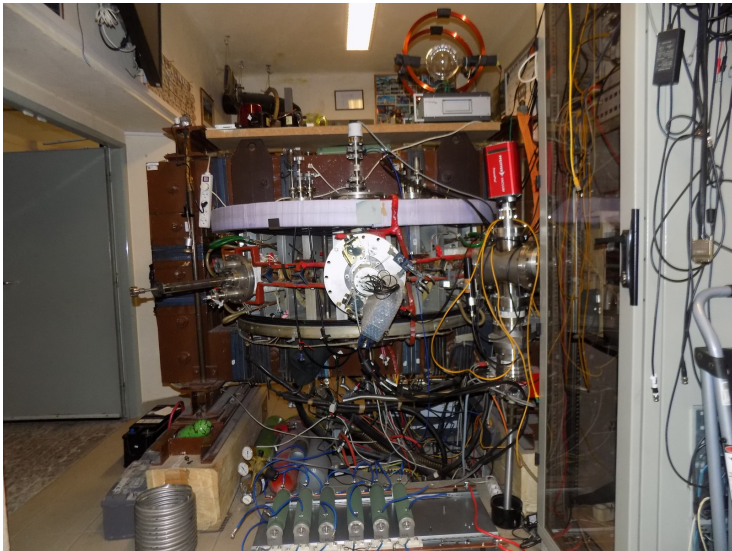

Tokamak room (North) 10/16

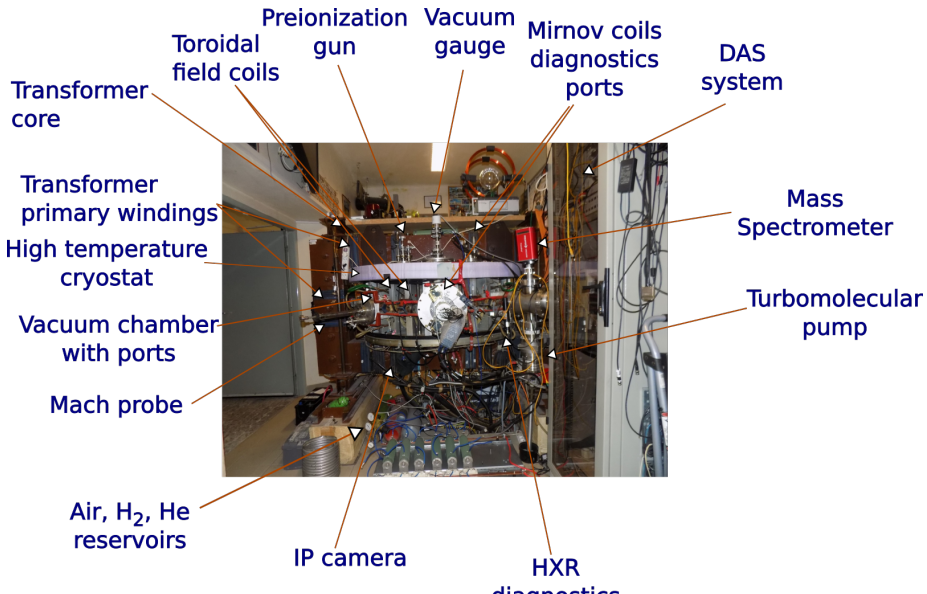

Tokamak room (South) 10/16

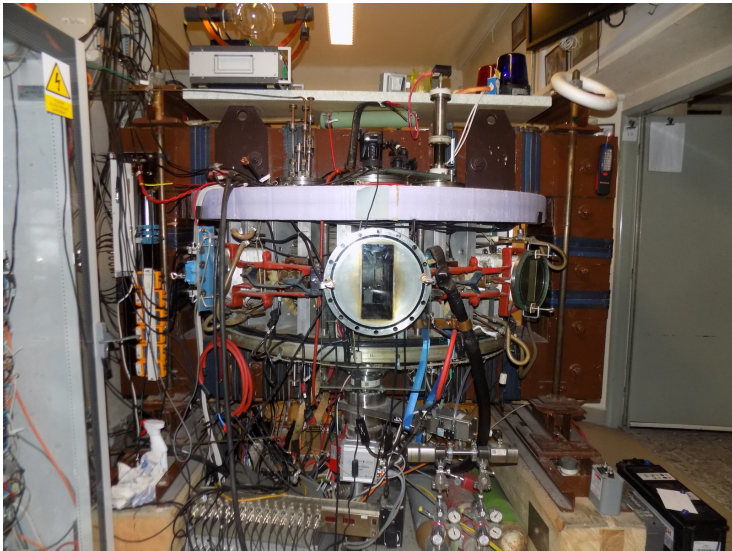

Tokamak room (South) 10/16

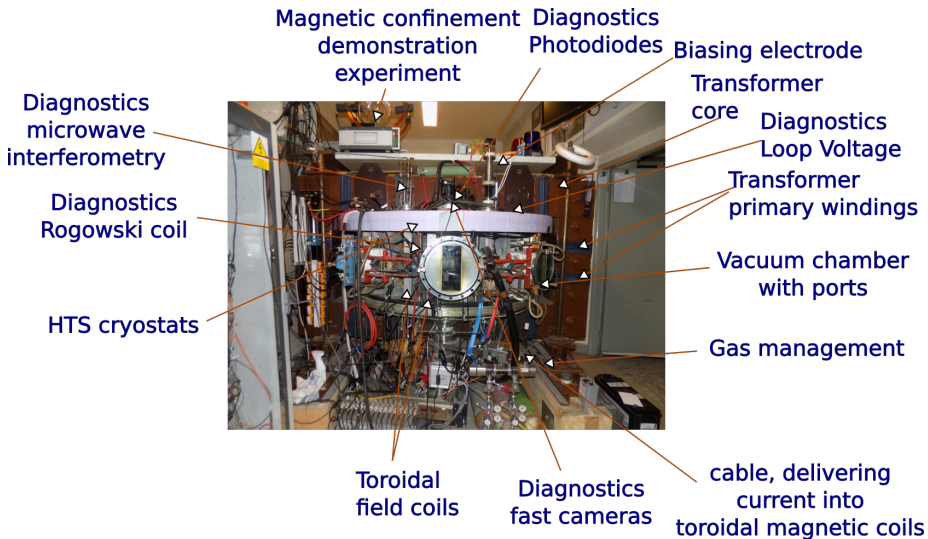

Table of Contents

1 Introduction

2 The Tokamak (GOLEM)

- The GOLEM tokamak concept
- The scenario to make the (GOLEM) tokamak discharge
- The scenario to discharge virtually
- The GOLEM tokamak - guide tour
- The GOLEM tokamak basic diagnostics

3 The Tokamak GOLEM (remote) operation

4 Conclusion

5 Appendix

The GOLEM tokamak - basic diagnostics

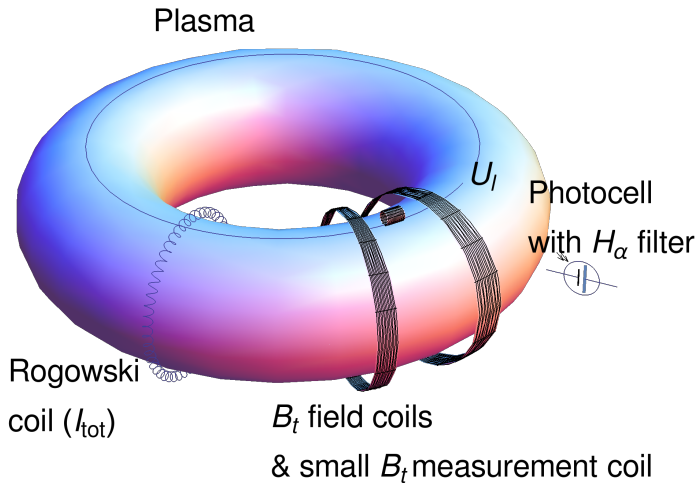

Hands on the GOLEM tokamak - equipment



Basic diagnostics - numerical processing, shot homepage

GOLEM - Shot #39187

Tokamak GOLEM - Shot Database - #39187

The date of discharge execution: 22-05-18 17:55:04
The session mission: GOLEM -> EDU (MHD + biasing)
The session ID: 39183
The discharge comment: Vert & Rad Stab
Discharge command:
`logp, /Dirigent.sh --discharge --UBT 1200 --TBT 0 --Ucd 450 --Tcd 350 --preionization 1 --gas H --pressure 10 --diagnostics.limitermimovcoils "vacuum_shot=39109" --discharge.preionization "main_switch='on',powsup_heater=B0,powsup_accel=100" --discharge.position_stabilization "main_switch='on',radial_switch='on',vertical_waveform=3000,0;9000,-20;18000,0;20000,0;30000,0;vertical_switch='on',radial_waveform=2000,0;3000,0;8000,-20;18000,0;19000,0;25000,0" --ScanDefinition "39184 39185" --comment "Vert & Rad Stab"`

Technological parameters

- Working Gas: $p_{\text{discharge,HeIe}} = 1,66 \text{ mPa}$; $p_{\text{discharge,HeII}} = 10,40 \text{ mPa}$ ($p_{\text{HeIe}}^{\text{request}} = 10 \text{ mPa}$ @ $A_{\text{WGI}}^{\text{request}} = H$)
- Toroidal magnetic field: $U_{\text{HeIe}}^{\text{request}} = 1200 \text{ V}$ @ $I_{\text{HeIe}} = 0,0 \text{ us}$
- Current drive field: $U_{\text{HeII}}^{\text{request}} = 450 \text{ V}$ @ $I_{\text{HeII}}^{\text{request}} = 350,0 \text{ us}$

Plasma

- Plasma: yes or no:
- Time parameters: $\Delta t_p = 15,08 \text{ ms}$ (from: $t_{\text{start}} = 2,49 \text{ ms}$, to: $t_{\text{end}} = 17,57 \text{ ms}$)

Plasma parameters

- Loop voltage: $U_{\text{loop}} = 8,02 \text{ V}$; $m_{\text{HeIe}}[\text{discharge}] U_{\text{loop}} = 9,89 \text{ V}$; $U_{\text{limdown}} = 10,83 \text{ V}$
- Toroidal magnetic field: $\bar{B}_t = 0,40 \text{ T}$; $\text{MAX}_{\text{HeIe}}[\text{discharge}] \bar{B}_t = 0,57 \text{ T}$

On stage diagnostics

Data flow: measurement → digitization → analysis

Name	Experiment setup	Data acquisition system	Raw data	Analysis results
Basic Diagnostics				

Basic diagnostics - numerical processing, raw data

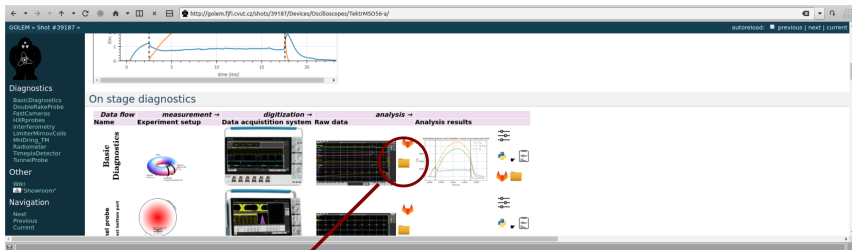

Index of /shots/39187/Devices/Oscilloscopes/TektrMSO56-a

[Name](#) [Last modified](#) [Size](#) [Description](#)

Parent Directory	-		
BasicDiagnostics.sh	2022-05-18 17:58	3.2K	
ScreenshotAll.png	2022-05-18 17:58	184K	
TektrMSO56_ALL.csv	2022-05-18 17:58	3.9M	
Universals.sh	2022-05-18 17:58	1.2K	
das.jpg	2022-05-18 17:58	13K	
ls-all	2022-05-18 17:58	2.4K	
rawdata.jpg	2022-05-18 17:58	13K	

Apache/2.4.38 (Debian) Server at golem.fjfi.cvut.cz Port 80

Basic diagnostics - numerical processing, Jupyter-notebook@GitLab Download & play

The screenshot displays a GitLab repository page for the project "Tokamak GOLEM Basic diagnostics". The page is viewed in a web browser, showing the repository's navigation sidebar on the left and the notebook content in the main area.

Repository Sidebar:

- Dirigent
- Project information
- Repository
- Files
- Commits
- Branches
- Tags
- Contributors
- Graph
- Compare
- Locked Files
- Issues (0)
- Merge requests (0)
- CI/CD
- Deployments
- Collapse sidebar

Notebook Content:

StandardDAS.ipynb 19.83 KiB

Tokamak GOLEM Basic diagnostics

Procedure ([This notebook to download](#))

[bash wrapper](#), [Error log](#)

Prerequisites: function definitions

Load libraries

```
%matplotlib inline
import os
import numpy as np
import matplotlib.pyplot as plt
from scipy import constants, integrate, signal, interpolate
import sqlalchemy # high-level library for SQL in Python
import pandas as pd
import subprocess
```

Basic diagnostics - numerical processing, Jupyter-notebook applied on the Discharge



The screenshot shows a Jupyter notebook interface with a dashboard at the top. The dashboard includes a sidebar with a 'Diagnostics' logo, a main area with tabs for 'Name', 'Experiment setup', 'Data acquisition system', 'Raw data', and 'Analysis results'. A plot of 'Time [s]' is visible, with a red circle around a download icon. A red arrow points from this icon to the notebook content below.

Procedure ([This notebook to download](#))

[bash wrapper](#), [Error log](#)

Prerequisites: function definitions

Load libraries

```
In [1]: %matplotlib inline
import os
import numpy as np
import matplotlib.pyplot as plt
from scipy import constants, integrate, signal, interpolate
import sqlalchemy # high-level library for SQL in Python
import pandas as pd
import subprocess
```

For interactive web figures

```
In [2]: import holoviews as hv
hv.extension('bokeh')
import hvplot.pandas
```



For conditional rich-text boxes

```
In [3]: from IPython.display import Markdown
```

Loop voltage U_l @ the GOLEM tokamak

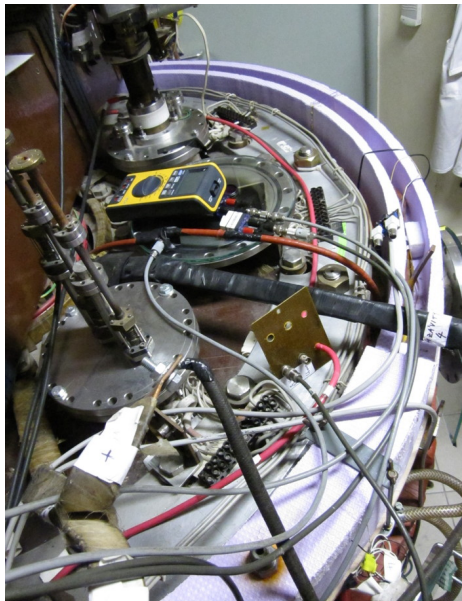
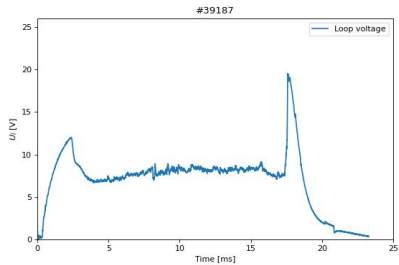
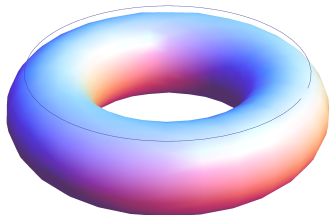

Basic diagnostics - numerical processing, U_{loop}

```
t_scale = 1e-3 if in_seconds else 1
if is_plasma:
    for t in (t_plasma_start, t_plasma_end):
        plt.axvline(t = t_scale, color='k', linestyle='--')
```

U_l management

Check the data availability

```
In [11]: loop_voltage = read_signal(shot_no, 'U_Loop')
polarity_CD = read_parameter(shot_no, 'CD_orientation')
if polarity_CD != 'CW': # T000 hardcoded for now!
    loop_voltage *= -1 # make positive
loop_voltage = correct_inf(loop_voltage)
loop_voltage.loc[it_CD] = 0
ax = loop_voltage.plot(grid=True)
show_plasma_limits()
ax.set(xlabel='Time [s]', ylabel='$U_L$ [V]', title='Loop voltage $U_L$ #{}'.format(shot_no));
```

```
Out[11]: [Text(0.5, 0, 'Time [s]'),
Text(0, 0.5, '$U_L$ [V]'),
Text(0.5, 1.0, 'Loop voltage $U_L$ #39187')]
```

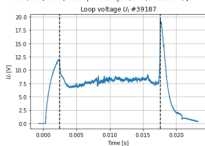

B_t calculation

Check the data availability

It is as magnetic measurement, so the raw data only give $\frac{dB_t}{dt}$

```
In [12]: dBt = read_signal(shot_no, 'U_BtCoil')
polarity_BT = read_parameter(shot_no, 'BT_orientation')
if polarity_BT != 'CW': # T000 hardcoded for now!
    dBt *= -1 # make positive
dBt = correct_inf(dBt)
dBt -= dBt.loc[offset_s1].mean()
ax = dBt.plot(grid=True)
show_plasma_limits()
ax.set(xlabel='Time [s]', ylabel='$dB_t/dt$ [V]', title='BTCoil raw signal #{}'.format(shot_no));
```

Toroidal magnetic field B_t @ the tokamak GOLEM

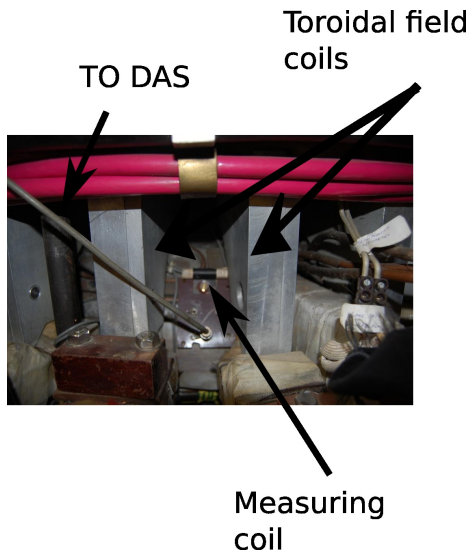
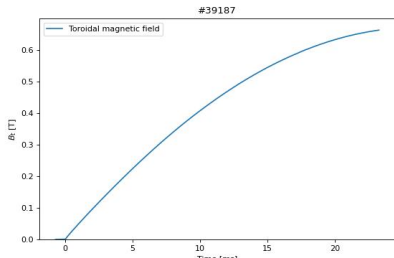

Basic diagnostics - numerical processing, B_t

B_t calculation

Check the data availability

It is as magnetic measurement, so the raw data only give $\frac{dB_t}{dt}$

```
In [12]: dBt = read_signal(shot_no, '0_BtCoil')
polarity_Bt = read_parameter(shot_no, 'Bt_orientation')
if polarity_Bt != 'CW':
    dBt *= -1 # make positive # 1000 hardcoded for now!
dBt = correct_inf(dBt)
dBt = dBt.loc[offset_sl].mean()
ax = dBt.plot(grid=True)
show_plasma_limits()
ax.set(xlabel='Time [s]', ylabel='dBt [B t]/dt [V]', title='BtCoil_raw signal #{}'.format(shot_no));
```

```
Out[12]: [Text(0.5, 0, 'Time [s]'),
Text(0, 0.5, 'dBt [B t]/dt [V]'),
Text(0.5, 1.0, 'BtCoil_raw signal #39187')]
```

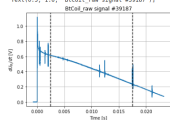

Integration (It is a magnetic diagnostic) & calibration

```
In [13]: K_BtCoil = float(read_parameter(shot_no, 'SystemParameters/K_BtCoil')) # Get BtCoil calibration factor
print('BtCoil calibration factor K_BtCoil={}'.format(K_BtCoil))
BtCoil calibration factor K_BtCoil=70.42 T/Vs)
```

```
In [14]: Bt = pd.Series(integrate.cumtrapz(dBt, axis=dBt.index, initial=0) * K_BtCoil,
index=dBt.index, name='Bt')
ax = Bt.plot(grid=True)
show_plasma_limits()
ax.set(xlabel='Time [s]', ylabel='Bt [T]', title='Toroidal magnetic field Bt ts #{}'.format(shot_no));
```

```
Out[14]: [Text(0.5, 0, 'Time [s]'),
Text(0, 0.5, 'Bt [T]'),
Text(0.5, 1.0, 'Toroidal magnetic field Bt ts #39187')]
```

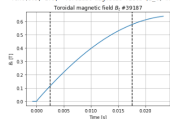

Total current I_{ch+p}

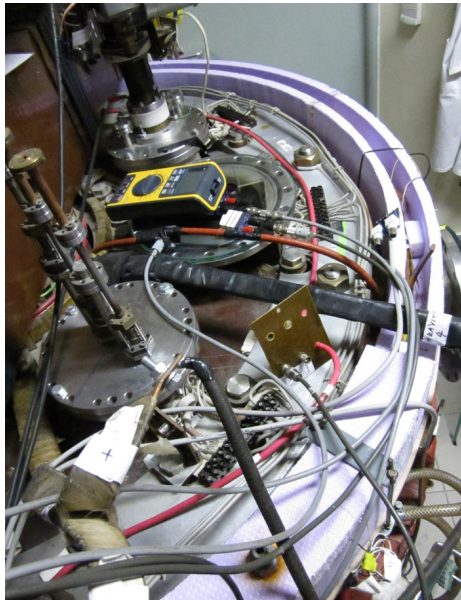
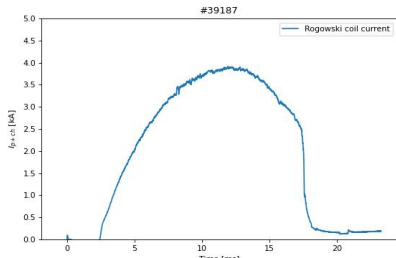
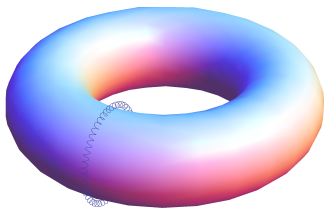

Basic diagnostics - numerical processing, U_{ch+p}

http://system.fyi.cvut.cz/shots/39187/Diagnostics/BasicDiagnostics/analysis.html

Chamber (+ Plasma) current I_{p+ch} calculation

The Rogowski coil around the chamber measures the total current contained within its boundaries. Therefore, if there is plasma, it measures the sum of the plasma and chamber currents. In a vacuum discharge it measures only the chamber current.

Check the data availability

Because it is a magnetic measurement, the raw data only gives $\frac{dI_{p+ch}}{dt}$

```
In [131]: dIpch = read_signal(shot_no, 'I_RogCoil') # 3300 horizontal bar now
if plotting_02 == 'ON':
    dIpch *= 1 # user sensitive
dIpch = correct_bias(dIpch)
dIpch = dIpch.loc[('Fast_s1', None)] # subtract offset
dIpch.loc['I_02'] = 0
ax = dIpch.plot(grid=True)
show_plasma_limits()
ax.set(xlabel='Time [s]', ylabel='dI_{p+ch} [A/s]', title='RogowskiCoil_raw_signal_#131'.format(shot_no));
```

```
Out[131]: Text(0, 0, 'Time [s]')
Text(0, 0.2, '400 [A/s] (0.04 [A/s])')
Text(0.0, 0.4, 'RogowskiCoil_raw_signal_#131#1')
RogowskiCoil_raw_signal_#131#1
```

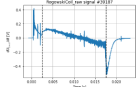

Integration (it is a magnetic diagnostic) & calibration

```
In [136]: K_RogowskiCoil = float(read_parameter(shot_no, 'SystemParameters/K_RogowskiCoil')) # get RogowskiCoil calibration factor
print('RogowskiCoil calibration factor: K_RogowskiCoil={0:0.000000} A/(V*s)'.format(K_RogowskiCoil))
```

```
In [137]: Spch = pd.Series(integrate.cumtrapz(dIpch, sorted_index, initial=0) * K_RogowskiCoil,
                      index=sorted_index, name='Spch')
ax = Spch.plot(grid=True)
show_plasma_limits()
ax.set(xlabel='Time [s]', ylabel='SI [pA/s] [A]', title='Total (plasma+chamber) current SI_#137'.format(shot_no));
```

```
Out[137]: Text(0, 0, 'Time [s]')
Text(0, 0.4, '400 [A/s] (0.04 [A/s])')
Text(0.0, 0.4, 'Total (plasma+chamber) current SI_#137#1')
Total (plasma+chamber) current SI_#137#1
```

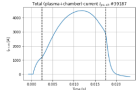

Chamber current I_{ch} calculation

```
In [138]: R_chamber = float(read_parameter(shot_no, 'SystemParameters/R_chamber')) # get Chamber resistivity
print('Chamber resistivity R_chamber={0} Ohm'.format(R_chamber))
```

Chamber resistivity R_chamber=0.007 Ohm

```
In [139]: L_chamber = float(read_parameter(shot_no, 'SystemParameters/L_chamber')) # get Chamber inductance
print('Chamber inductance L_chamber={0} H'.format(L_chamber))
Chamber inductance L_chamber=4e-06 H
```

```
In [141]: for i in range(1, len(shots)):
    ax = i.plot()
    ax.legend()
    show_plasma_limits()
    ax.set(xlabel='Time [s]', ylabel='SI [A]', title='estimated chamber current and measured total')
    plt.grid()
```

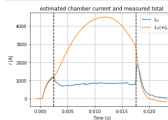

Plasma current I_p calculation

If there is plasma, the plasma current can be estimated as the difference between the total measured current and the estimated chamber current $I_p = I_{p+ch} - I_{ch}$

```
In [121]: if is_plasma:
    Ip_raw = Ipch - loop_voltage/R_chamber # creates a new Series
    Ip = Ipch - I_ch
    Ip.name = 'Ip'
    Ip_raw.plot(grid=True, label='raw SI (ch+d, I, R (ch)')
    ax = Ip.plot(grid=True, label='using SI_L = R_ch I_ch - L_ch / (rcd I_ch) [A]')
    ax.legend()
    show_plasma_limits()
    ax.set(xlabel='Time [s]', ylabel='SI (p) [A]', title='Plasma current SI_(p) #121'.format(shot_no));
else:
    Ip = Ipch * 0 # no current
    heading
```

Out[121] Plasma detected

plasma lifetime of 15.1 ms, from 2.5 ms to 17.6 ms

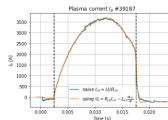

```
In [131]: fig = plt.figure(dpi=200)
for i in range(1, len(shots)):
    ax = i.plot()
```

Visible radiation

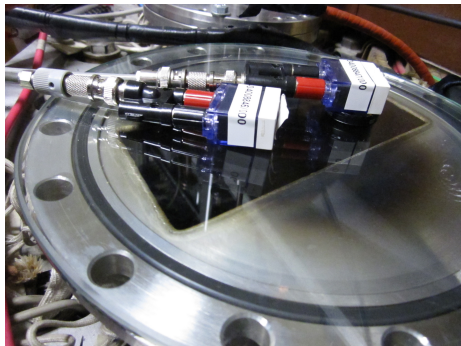
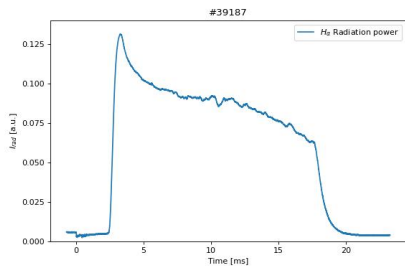
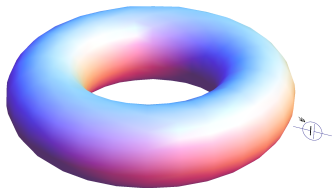

Electron density n_e interferometry measurement scheme

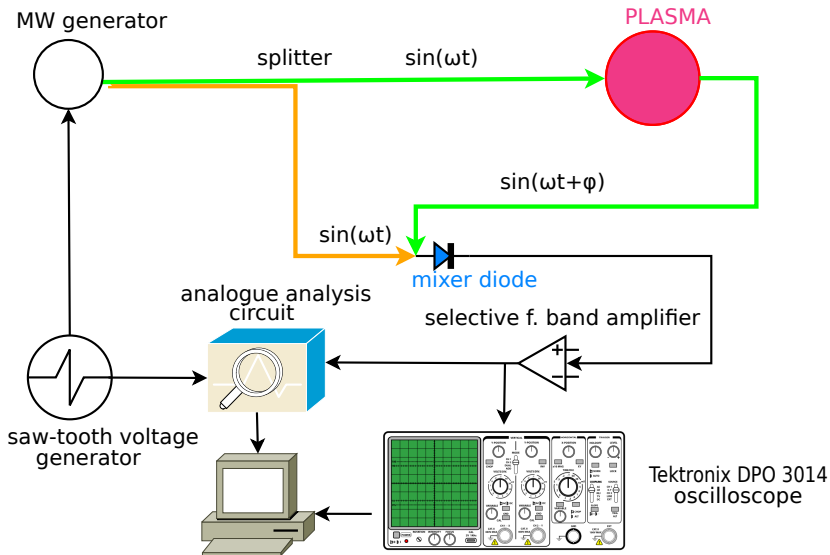

The GOLEM tokamak interferometry HW

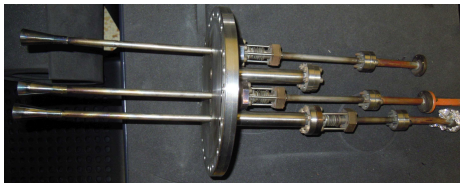

Finally "Typical", well executed discharge @ GOLEM

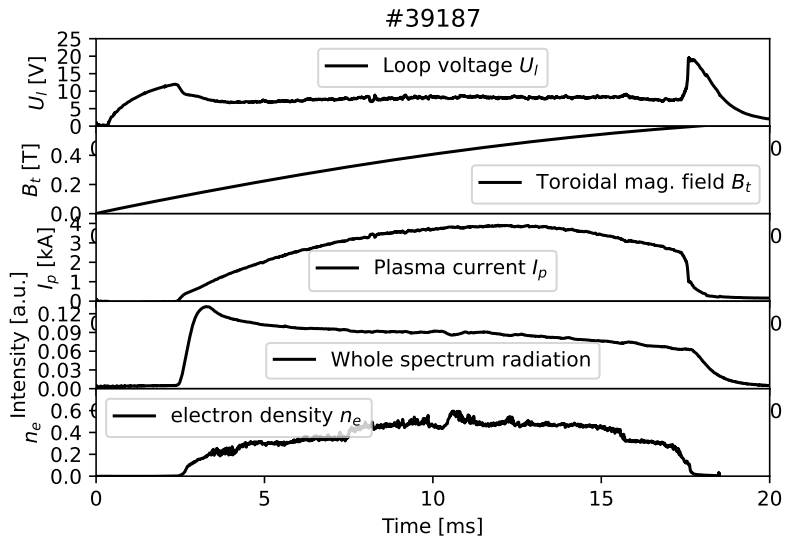

Shot homepage (≈ 2 minutes after discharge execution)

GOLEM # Shot #40631
autoreload



Diagnostics

BasicDiagnostics
DontUseRakeProbe
Interferometry
LimiterMiscCoils
ScribbleRakeProbes

Other

View
Showroom

Navigation

Next
Previous
Current

Go to shot
40631

Golem utils

Home
Plot data
Shot manual plot
Manipulators control

Database operations

Shots listing
Shots filtering

Tokamak GOLEM - Shot Database - #40631

The date of discharge execution 23-02-07 17:23:54

The session mission 1Final -> Dringit service

The session ID 40605

The discharge comment Rake probe 50mm

Discharge command jDringit.sh --discharge --UBt 800 --Tbt 0 --Utd 450 --Tot 500 --preionization 1 --gas H --pre issue 15 --diagnostics.limitermisccoils.vacuum_shot=40615F --discharge.preionization "m air_switch=on;powsup_heater=80;powsup_accel=100" --infrastructure.position_stabilization "main_switch=on;radial_switch=on;vertical_waveform=1000,0.8000,-20,10000,-25,12000,-10,30000,0;vertical_switch=on;radial_waveform=2000,0.3000,0.7000,-20,9500,-25,10000,-20,30000,2,25000,0" --ScanDefinition 40625 40629F --comment "Rake probe 50mm"

[Shot Logbook]

Technological parameters

- Working Gas: $P_{discharge, before} = 2.46$ mPa; $P_{discharge, pre} = 5.04$ mPa ($P_{WG}^{request} = 15$ mPa @ $\Delta_{WG}^{request} = H$)
- Toroidal magnetic field: $U_{B_t}^{request} = 800$ V @ $I_{B_t}^{request} = 0.0$ us
- Current drive field: $U_{Ecd}^{request} = 450$ V @ $I_{Ecd}^{request} = 500.0$ us

Plasma:

- Plasma: yes or no:
- Time parameters: $\Delta T_p = 10.88$ ms ($t_{rom, start} = 2.67$ ms, $t_{rom, end} = 13.54$ ms)

Plasma parameters:

- Loop voltage: $\bar{U}_{loop} = 6.82$ V; $max_{T_{inj}}(I_{discharge}) U_{loop} = 16.17$ V; $U_{loop, down} = 0.00$ V
- Toroidal magnetic field: $B_t = 0.24$ T; $max_{T_{inj}}(I_{discharge}) B_t = 0.36$ T
- Plasma current: $I_p = 2.28$ kA; $max_{T_{inj}}(I_{discharge}) I_p = 2.92$ kA; $t_p^{max} = 0.00$ ms

Basic Diagnostics

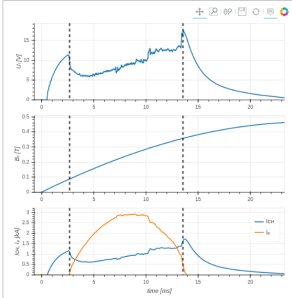

On stage diagnostics









	Data flow	measurement	digitization	analysis	
Name	Experiment setup	Data acquisition system	Raw data	Analysis results	
Basic Diagnostics					<input type="button" value="Plot"/> <input type="button" value="Table"/>
Double rake probe					Without Analysis <input type="button" value="Plot"/> <input type="button" value="Table"/>

Table of Contents

- 1 Introduction
- 2 The Tokamak (GOLEM)
- 3 The Tokamak GOLEM (remote) operation**
- 4 Conclusion
- 5 Appendix

Table of Contents

- 1 Introduction
- 2 The Tokamak (GOLEM)
- 3 The Tokamak GOLEM (remote) operation**
 - Control room
 - Data handling @ the Tokamak GOLEM
- 4 Conclusion
- 5 Appendix

Remote control interface of the GOLEM tokamak

Introduction Working gas Preionization Magnetic field Electric field Submit

Set the pressure and type of the working gas from which the plasma is formed. Pressure must be high enough for plasma to form, but low enough for gas breakdown to occur.

Preionization (electron gun)

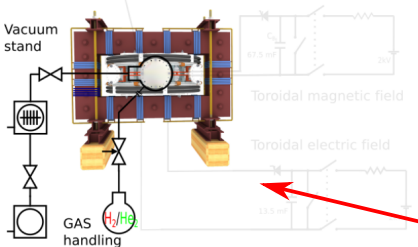

Vacuum stand

GAS handling H_2/He

Toroidal magnetic field

Toroidal electric field

Gas type and pressure $p_{WG} = 16 \text{ mPa}$

Hydrogen Helium

Next Set recommended value

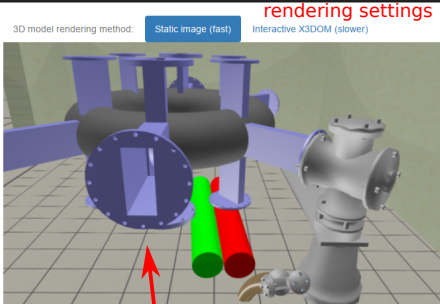

3D model rendering

engineering scheme

sliders and checkboxes

workflow buttons

Control room: Introduction

GOLEM remote Introduction **Control room** Live Results

Prague Access: Level 1 Help

Introduction Working gas Preionization Magnetic field Current drive Submit

This web interface will walk you through the process of configuring a discharge in the GOLEM tokamak. All settable values are perfectly safe. Proceed through each step by setting the desired values and then clicking the [Next](#) button. You can always go to a specific step by clicking its tab.

Preionization (electron gun)

Vacuum stand

Toroidal magnetic field

Preionization (electron gun)

Current drive

GAS handling H_2/He

23 mF C_p

11.3 mF C_p

2kV

2kV

3D model rendering method: **Static image (fast)** Interactive X3DOM (slower)

[Next](#)

Control room: Working gas

GOLEM remote Introduction Control room Live Results

Introduction Working gas Preionization Magnetic field Electric field Submit

Set the pressure and type of the working gas from which the plasma is formed. Pressure must be high enough for plasma to form, but low enough for gas breakdown to occur.

Preionization (electron gun)

Vacuum stand

Toroidal magnetic field

Toroidal electric field

GAS handling

H_2/H_2O

Gas type and pressure $p_{gas} = 38 \text{ mPa}$

Hydrogen Helium

Next Set recommended value

3D model rendering method Static image (best) Interactive X3DOM (slower)

Control room: Preionization

GOLEM remote Introduction Control room Live Results

Introduction Working gas Preionization Magnetic field Electric field Submit

The neutral working gas must be first ionized in order to break down into a plasma. Using the electron gun will locally ionize the gas. Without any ionization, no plasma can form.

Preionization (electron gun)

Vacuum stand

GAS handling

Toroidal magnetic field

Toroidal electric field

67.5 mH

20V

13.5 mF

20V

ionization method

Electron gun No ionization

Next

3D model rendering method Static image (best) Interactive X3DOM (preview)

Control room: Magnetic field B_t

GOLEM remote Introduction Control room Live Results

the Torus Politecnico, Italy Group 1 Access Level 2 Help

Introduction Working gas Preionization **Magnetic field** Electric field Submit

Press F11 to exit full screen 3D model rendering method Static image (best) Interactive X3DOM (viewer)

Set the voltage on the capacitors to be discharged into the toroidal field coils. The higher the voltage, the larger the magnetic field confining the plasma.

Preionization (electron gun)

Vacuum stand

Toroidal magnetic field

Toroidal electric field

GAS handling

Capacitor voltage $U_{C_1} = 600\text{ V}$

Next Set recommended value

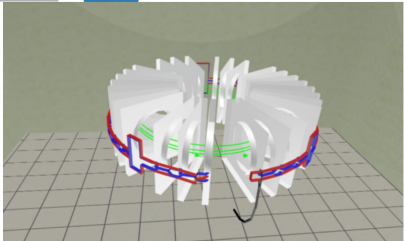

Control room: Current drive E_{cd}

GOLEM remote Introduction Control room Live Results

the Torneo Politecnico, Italy Group 1 Access: Level 2 Help

Introduction Working gas Preionization Magnetic field **Electric field** Submit

Set the voltage on the capacitors to be discharged into the [primary transformer winding](#). The higher the voltage, the larger the electric field creating and heating the plasma. The electric field capacitors are discharged after a configurable delay with respect to the magnetic field capacitors.

Preionization (electron gun)

Vacuum stand

Toroidal magnetic field

Toroidal electric field

GAS handling

Time delay of electric field start after the magnetic field starts t_{cd} : 0 micro seconds

Capacitor voltage U_{cd} : 400 V

Next Set recommended value

3D model rendering method Static image (best) Interactive X3DOM (preview)

Control room: ... and Submit

GOLEM remote Introduction Control room Live Results

the Torneo Politecnico, Italy Group 1 Access: Level 2 Help

Introduction Working gas Prescription Magnetic field Electric field **Submit**

Write a comment describing your discharge configuration, i.e. the scientific aim of your experiment. Or just leave a friendly message.

Comment

Click the Submit button to send your configuration into the queue. **Submit**

After submission you can watch the discharge Live or go back to the Introduction tab and start again. Or you can go to specific control tabs and reconfigure the discharge and then submit another discharge request.

[Watch the discharge Live!](#) [Go back to Introduction](#)

3D model rendering method: [Static image \(best\)](#) [Interactive X3DOM \(slower\)](#)

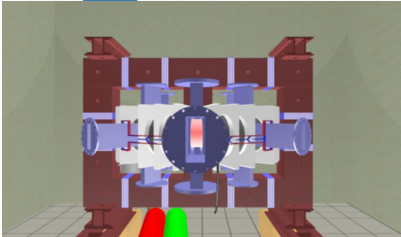

Shot homepage (≈ 2 minutes after discharge execution)

GOLEM # Shot #40631
autoreload



Diagnostics

BasicDiagnostics
DontUseRakeProbe
Interferometry
LimiterMicroVista
ScribbleRakeProbes

Other

View
Showroom

Navigation

Next
Previous
Current

Go to shot
40631

Golem utils

Home
Plot data
Shot manual plot
Manipulators control

Database operations

Shots listing
Shots filtering

Tokamak GOLEM - Shot Database - #40631

The date of discharge execution 23-02-07 17:23:54

The session mission 1Final -> Dringit service

The session ID 40605

The discharge comment Rake probe 50mm

Discharge command jDringit.sh --discharge --UBt 800 --Tbt 0 --Utd 450 --Tot 500 --preionization 1 --gas H --pre issue 15 --diagnostics.limitermicrovists "vacuum_shot=40615" --discharge.preionization "m air_switch=on;powsup_heater=80;powsup_accel=100" --infrastructure.position_stabilization "main_switch=on;radial_switch=on;vertical_waveform=1000,0.8000,-20,10000,-25,12000,-10,30000,0;vertical_switch=on;radial_waveform=2000,0.3000,0.7000,-20,9500,-25,10000,-20,30000,2,25000,0" --ScanDefinition 40625 40629 --comment "Rake probe 50mm"

[Shot Logbook]

Technological parameters

- Working Gas: $P_{discharge, before} = 2.46$ mPa; $P_{discharge, pre} = 5.04$ mPa ($P_{WG}^{request} = 15$ mPa @ $\Delta_{WG}^{request} = H$)
- Toroidal magnetic field: $U_{B_t}^{request} = 800$ V @ $I_{B_t}^{request} = 0.0$ us
- Current drive field: $U_{Etd}^{request} = 450$ V @ $I_{Etd}^{request} = 500.0$ us













Plasma:

- Plasma: yes or no:
- Time parameters: $\Delta T_p = 10.88$ ms ($t_{onset} = 2.67$ ms, $t_{end} = 13.54$ ms)

Plasma parameters:

- Loop voltage: $\overline{U}_{loop} = 6.82$ V; $max_{T_p}(dI_{charge})/U_{loop} = 16.17$ V; $U_{loop, end} = 0.00$ V
- Toroidal magnetic field: $B_t = 0.24$ T; $max_{T_p}(dI_{charge})/B_t = 0.36$ T
- Plasma current: $I_p = 2.28$ kA; $max_{T_p}(dI_{charge})/I_p = 2.92$ kA; $t_p^{max} = 0.00$ ms

On stage diagnostics

Data flow	measurement	digitization	Raw data	analysis	Analysis results
Name	Experiment setup	Data acquisition system	Raw data	Analysis	Analysis results
<p>Basic Diagnostics</p> 					
<p>Double rake probe</p> 				<p>Without Analysis</p> 	

Basic Diagnostics

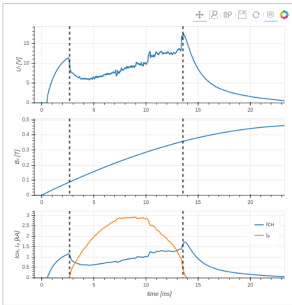

Table of Contents

- 1 Introduction
- 2 The Tokamak (GOLEM)
- 3 The Tokamak GOLEM (remote) operation**
 - Control room
 - Data handling @ the Tokamak GOLEM
- 4 Conclusion
- 5 Appendix

GOLEM basic Data Acquisition System (DAS)

- $U_I, U_{B_t}, U_{I_{p+ch}}, I_{rad}$
- $\Delta t = 1\mu s / f = 1MHz$.
- Integration time = 40 ms, thus DAS produces 6 columns x 40000 rows data file.
- Discharge is triggered at 5th millisecond after DAS to have a zero status identification.



Data file example, DAS $\Delta t = 1\mu s / f = 1MHz$ (neutral gas into plasma breakdown focused)

t	$\approx U_I$	$\approx U_{\frac{dB_T}{dt}}$	$\approx U_{\frac{d(I_{p+ch})}{dt}}$	$\approx I_{rad}$
:	:	:	:	:
:	:	:	:	:
first	\approx	7405	lines ..	:
:	:	:	:	:
:	:	:	:	:
0.007383	1.53931	0.390015	0.048828	0.001831
0.007384	1.53686	0.395508	0.067749	0.00061
0.007385	1.54053	0.391235	0.079956	0.00061
0.007386	1.53686	0.38147	0.072632	0
0.007387	1.54297	0.397949	0.059204	0.00061
0.007388	1.54053	0.384521	0.05249	0.00061
0.007389	1.54053	0.39856	0.068359	0.001221
0.00739	1.54053	0.393677	0.082397	0.001221
0.007391	1.53809	0.38208	0.072632	0.001221
0.007392	1.54297	0.400391	0.056763	0.00061
0.007393	1.54419	0.383911	0.053101	0.00061
0.007394	1.53931	0.397339	0.068359	0.001221
0.007395	1.54297	0.391846	0.084229	0.00061
0.007396	1.54541	0.394897	0.074463	0.00061
0.007397	1.54297	0.388184	0.056763	0.001221
0.007398	1.54297	0.391846	0.056763	0.00061
0.007399	1.54297	0.394287	0.06897	0.00061
:	:	:	:	:
:	:	:	:	:
next	\approx	32500	lines ..	:
:	:	:	:	:
:	:	:	:	:

Data access

All the recorded data and the settings for each discharge (shot) are available at the GOLEM website. The root directory for the files is:

```
http://golem.fjfi.cvut.cz/shots/<#ShotNo>/
```

The most recent discharge has the web page:

```
http://golem.fjfi.cvut.cz/shots/0
```

Particular data from DAS specified with <DASname> and <DASchannelidentifier> have the format:

```
http:  
//golem.fjfi.cvut.cz/<#ShotNo>/<DASname>/<DASchannelidentifier>
```

Jupyter (python)

```
import numpy as np
import matplotlib.pyplot as plt

shot_no = 39187
identifier = "U_loop.csv"
DAS='Diagnostics/BasicDiagnostics/Results/'
# create data cache in the 'golem_cache' folder
ds = np.DataSource('golem_cache')
#Create a path to data and download and open the file
base_url = "http://golem.fjfi.cvut.cz/shots/"
data_file = ds.open(base_url + str(shot_no)+ '/' +DAS +identifier)
#Load data from the file and plot to screen and to disk
data = np.loadtxt(data_file,delimiter=",")
plt.title('#'+str(shot_no))
plt.plot(data[:,0]*1000, data[:,1]) #1. column vs 2. column
plt.xlabel('Time [ms]');plt.ylabel('$U_1$ [V]');
plt.savefig('graph.jpg')
plt.show()

#Run it: save it as script.py and run "python script.py" or execute in a
```

Matlab

```
ShotNo=39187
baseURL='http://golem.fjfi.cvut.cz/shots/';
diagnPATH='/Diagnostics/BasicDiagnostics/Results/U_loop.csv';
%Create a path to data
dataURL=strcat(baseURL,int2str(ShotNo),diagnPATH);
% Write data from GOLEM server to a local file
urlwrite(dataURL,'LoopVoltage');
% Load data
data = load('LoopVoltage', '\t');
% Plot and save the graph
f = figure('visible', 'off');
hold on
plot(data(:,1)*1000, data(:,2), '.');
xlabel('Time [ms]')
ylabel('U_1 [V]')
hold off
print -djpeg plot.jpg
close(f)
exit;
```

Octave

```
ShotNo=39187
baseUrl='http://golem.fjfi.cvut.cz/shots/';
diagnPATH='/Diagnostics/BasicDiagnostics/Results/U_loop.csv';
%Create a path to data
dataURL=strcat(baseUrl,int2str(ShotNo),diagnPATH);
% Write data from GOLEM server to a local file
urlwrite(dataURL,'U_Loop.csv');
% Load data
data = load('U_Loop.csv', '\t');
% Plot and save the graph
plot(data(:,1)*1000, data(:,2), '.');
xlabel('time [ms]')
ylabel('U_{loop} [V]')
saveas(gcf, 'plot', 'jpg');
exit;
```

Gnuplot

```
identifier = 'U_loop.csv' ;
ShotNo = '39187'
# Create a path to the data
DAS='Diagnostics/BasicDiagnostics/Results/'
baseURL='http://golem.fjfi.cvut.cz/shots/'
DataURL= baseURL.ShotNo.'/'.DAS.identifier
set datafile separator ',';
set title "Uloop for #".ShotNo;
! wget -q @DataURL ;# Write data from GOLEM erver to a local file
# Plot the graph from a local file
set xrange [0:0.02];set xlabel 'Time [s]';set ylabel 'U_1 [V]'
set terminal jpeg; plot identifier u 1:2 w l t 'Uloop'
```

```
shot_no=39187;\
signal_id="Diagnostics/BasicDiagnostics/Results/U_loop.csv";\
gnuplot -p -e "set title \"Golem\";set datafile separator \" , \";\
set xlabel \"t [s]\";set ylabel \"U\";\
plot \"< \
wget -q -O - http://golem.fjfi.cvut.cz/shots/$shot_no/$signal_id\" \
w l t \"U\""
```

GNU Wget

GNU Wget is a free software package for retrieving files using HTTP, HTTPS and FTP, the most widely-used Internet protocols. It is a non-interactive commandline tool, so it may easily be called from scripts, cron jobs, terminals without X-Windows support, etc.

- Runs on most UNIX-like operating systems as well as Microsoft Windows.
- Homepage: <http://www.gnu.org/software/wget/>
- Basic usage:
 - To get U_l : `wget http://golem.fjfi.cvut.cz/utis/data/<#ShotNo>/loop_voltage`
 - To get whole shot: `wget -r -nH -cut-dirs=3 -no-parent -l2 -Pshot http://golem.fjfi.cvut.cz/shots/<#ShotNo>`

Excel

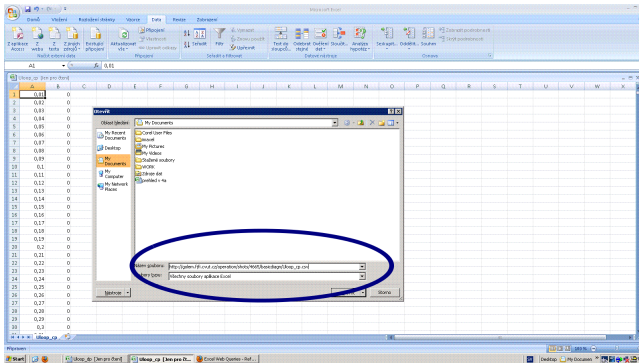

File→Open→

`http://golem.fjfi.cvut.cz/utills/data/<#ShotNo>/<identifier>`

Spreadsheets (Excel and others)

are not recommended, only tolerated.

Table of Contents

- 1 Introduction
- 2 The Tokamak (GOLEM)
- 3 The Tokamak GOLEM (remote) operation
- 4 Conclusion**
- 5 Appendix

The global schematic overview of the tokamak GOLEM experiment

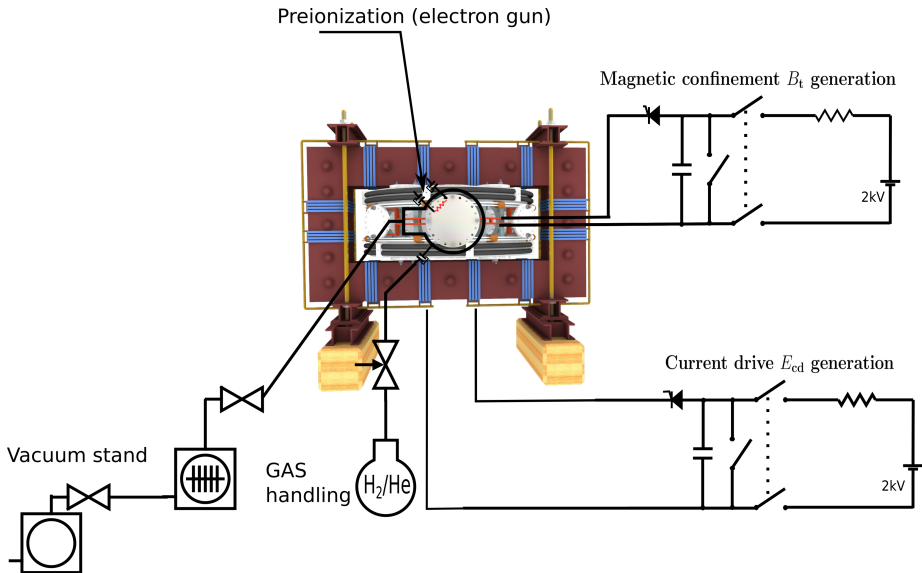

Production

- Everything via <http://golem.fjfi.cvut.cz/Torino>
 - This presentation
 - Control rooms
 - Contact: Vojtech Svoboda,
+420 737673903,
vojtech.svoboda@fjfi.cvut.cz
 - Videoconference:
<https://meet.google.com/hnv-qjhu-xvi>



Recommended values for the GOLEM tokamak operation

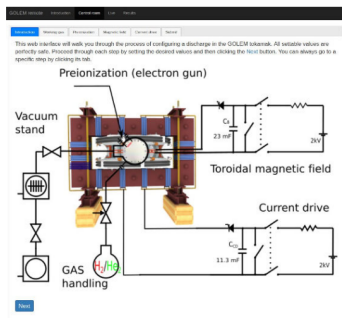

- Preionization: Top electron gun
- Gas: Hydrogen. A Working gas pressure: p_{WG} [mPa] $< 0, 40 >$ mPa
- A voltage to charge the Current drive field E_t capacitor: U_{E_t} [V] $< 400, 700 >$ V
- A voltage to charge the Toroidal magnetic field B_t capacitor: U_{B_t} [V] $< 600, 1200 >$ V
- Time delay of the E_t trigger with respect to the B_t trigger: T_{CD} [μ s] $< 0, 10000 >$ μ s

Acknowledgement

Financial support highly appreciated:

CTU RVO68407700, SGS 17/138/OHK4/2T/14, GAČR GA18-02482S, EU funds CZ.02.1.01/0.0/0.0/16_019/0000778 and CZ.02.2.69/0.0/0.0/16_027/0008465, IAEA F13019, FUSENET and EUROFUSION.

Students, teachers, technicians (random order):

Vladimír Fuchs, Ondřej Grover, Jindřich Kocman, Tomáš Markovič, Michal Odstrčil, Tomáš Odstrčil, Gergo Pokol, Igor Jex, Gabriel Vondrášek, František Žáček, Lukáš Matěna, Jan Stockel, Jan Mlynář, Jaroslav Krbec, Radan Salomonovič, Vladimír Linhart, Kateřina Jiráková, Ondřej Ficker, Pravesh Dhyani, Juan Ignacio Monge-Colepicolo, Jaroslav Čerovský, Bořek Leitl, Martin Himmel. Petr Švihra, Petr Mácha, Vojtěch Fišer, Filip Papoušek, Sergei Kulkov, Martin Imříšek.

Thank you for your attention

Tokamak TM1
@Kurchatov Institute near Moscow
~1960-1977

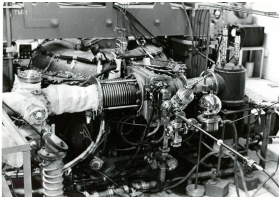

SCIENCE

Tokamak CASTOR
@Institute of Plasma Physics, Prague
1977-2007



**SCIENCE
& education**

Tokamak GOLEM
@Czech Technical University, Prague
2007-

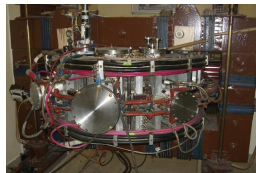

**EDUCATION
& science**

... with the biggest
control room
in the world ..

Tokamak Golem **REMOTE for MASTER (Level 1)**
The smallest & oldest operational tokamak with the biggest control room in the world

Home	Wiki	Control Room	Queue	Live	Results	GOLEM Diagram	Chamber status	IP cameras	3D model	Chat	Feedback	Logout
------	------	--------------	-------	------	---------	---------------	----------------	------------	----------	------	----------	--------

LEVEL 1

Preionization (electron gun)
Thresh

Toroidal magnetic field

Current drive

Vacuum stand

GAS handling

Working Gas (Deuterium)





Discharge comment

Place the discharge setup into the queue

Table of Contents

- 1 Introduction
- 2 The Tokamak (GOLEM)
- 3 The Tokamak GOLEM (remote) operation
- 4 Conclusion
- 5 Appendix**

References I

-  Wikipedia contributors. Golem — Wikipedia, the free encyclopedia. <https://en.wikipedia.org/w/index.php?title=Golem>, 2020. [Online; accessed 29-March-2020].
-  Brotankova, J. *Study of high temperature plasma in tokamak-like experimental devices*. PhD thesis, 2009.
-  Tokamak GOLEM contributors. Tokamak GOLEM at the Czech Technical University in Prague. <http://golem.fjfi.cvut.cz>, 2007. [Online; accessed November 11, 2024].
-  J. Wesson. *Tokamaks*, volume 118 of *International Series of Monographs on Physics*. Oxford University Press Inc., New York, Third Edition, 2004.

References II



-  [Wikipedia contributors](https://en.wikipedia.org/w/index.php?title=Lawson_criterion&oldid=888000448). Lawson criterion — Wikipedia, the free encyclopedia. https://en.wikipedia.org/w/index.php?title=Lawson_criterion&oldid=888000448, 2019. [Online; accessed 6-December-2019].
-  [ITER contributors](https://www.iter.org) . ITER. <https://www.iter.org>, 2007. [Online; accessed 21-December-2018].

Table of Contents

1 Introduction

2 The Tokamak (GOLEM)

3 The Tokamak GOLEM (remote) operation

4 Conclusion

5 Appendix

- The Electron energy confinement time calculation (rough estimation)
- A
- Few moments from the tokamak GOLEM history

Towards ... Energy confinement time

House

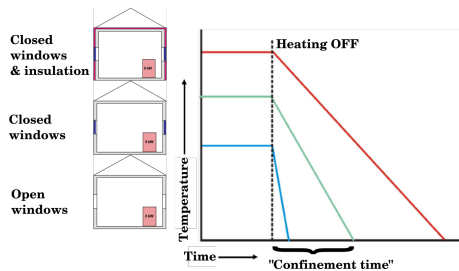

Tokamak

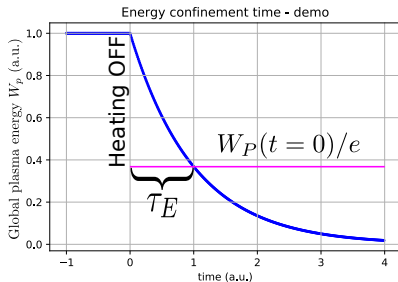

- Net power = Efficiency \times (Fusion - Radiation loss - Conduction loss)
- The confinement time: $\tau_E = \frac{W}{P_{\text{loss}}}$
- Energy density $W = 3nk_B T$ & rate of radiation and conduction energy loss per unit volume P_{loss}
- Reactions per volume per time of fusion reactions is:
 $f = n_d n_t \langle \sigma v \rangle = \frac{1}{4} n^2 \langle \sigma v \rangle$
- Fusion heating fE_{ch} , where $E_{\text{ch}} = 3.5 \text{ MeV}$ should exceed the losses:
 $fE_{\text{ch}} \geq P_{\text{loss}}$

$$n\tau_E \geq L \equiv \frac{12}{E_{\text{ch}}} \frac{k_B T}{\langle \sigma v \rangle} \geq 1.5 \cdot 10^{20} \frac{\text{s}}{\text{m}^3}$$

(DT reaction @ minimum $\approx 26 \text{ keV}$)

The competition

The ITER: 3.6 s

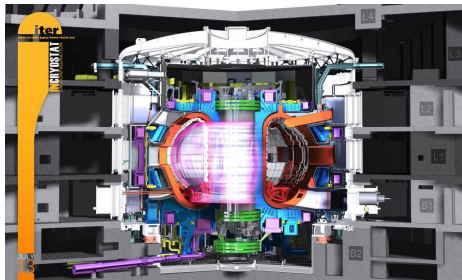

credit:[6]

The GOLEM: ??? s or ms or us ??

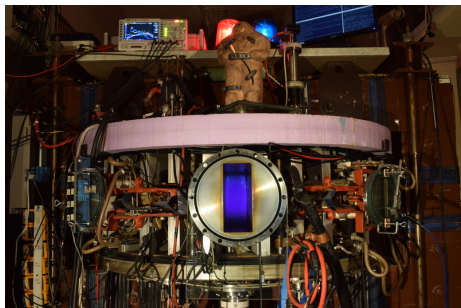

credit:[3]

Energy balance of the house

Closed windows & insulation

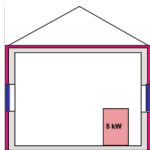

Closed windows

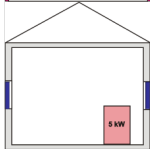

Open windows

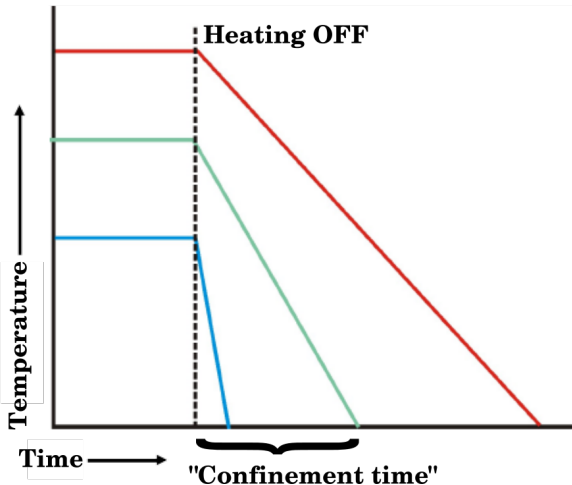
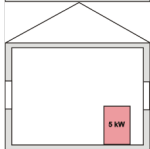

Energy balance of the tokamak

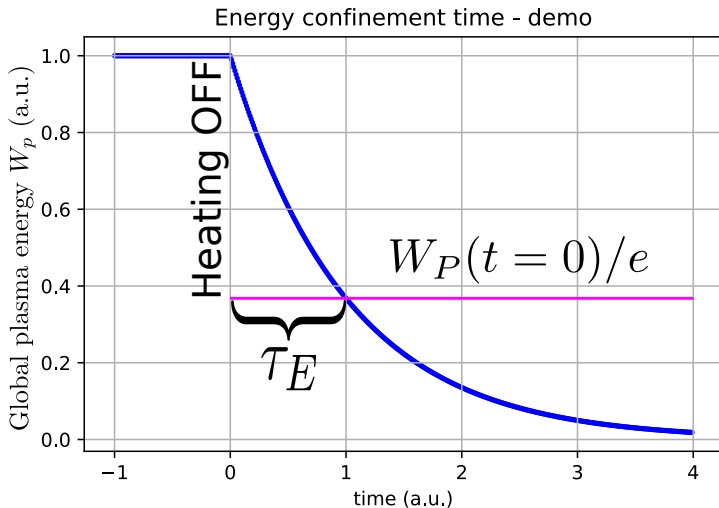

Energy confinement time

Under the assumption of a simplified power balance, the heating power P_H is partially absorbed in the plasma and leads to an increase of the plasma energy W_p and the rest is lost as the loss power P_{Loss}

$$P_H = \frac{dW_p}{dt} + P_{Loss}$$

The energy confinement time is defined as the characteristic time scale of the exponential decay of the plasma energy W_p due to the loss power P_{Loss} :

$$\tau_E = \frac{W_p}{P_{Loss}} = \frac{W_p}{P_H - dW_p/dt}$$

Choosing the quasistationary phase of the plasma discharge, where $\frac{dW_p}{dt} = 0$ gives:

$$\tau_E(t) = \frac{W_p(t)}{P_H(t)}$$

The discharge - quasistationary phase

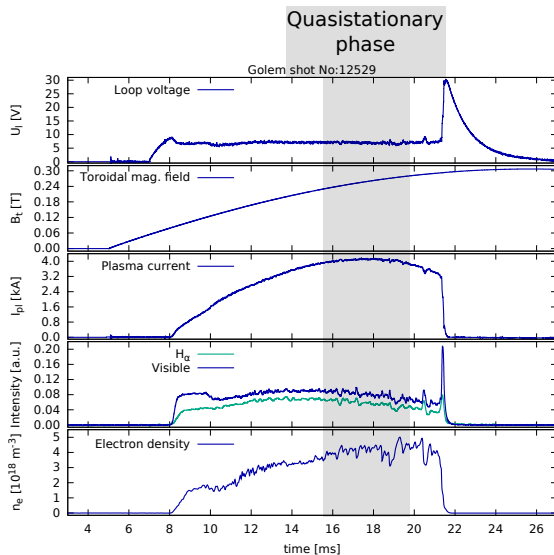

Plasma heating power

On the GOLEM tokamak the only heating mechanism of the plasma is ohmic heating P_{OH} resulting from the plasma current I_p flowing in a conductor with finite resistivity R_p . The time dependence of the ohmic heating power can be calculated as:

$$P_H(t) = P_{OH}(t) = R_p(t) \cdot I_p^2(t)$$

Plasma Energy

The global plasma energy content W_p can be simply calculated from the temperature estimation $T_e(0, t)$, average density n_e and plasma volume V_p , based on the ideal gas law, taking into account the assumed

$T_e(r, t) = T_e(0, t) \left(1 - \frac{r^2}{a^2}\right)^2$ temperature profile:

$$W_p(t) = V_p \frac{n_e k_B T_e(0, t)}{3}.$$

The information that the magnetic field reduces the degrees of freedom of the particles to two has been used to derive this formula.

- $V_p \approx 80 \text{ l}$

Central Electron Temperature estimation (Spitzer Formula)

The time evolution of the central electron temperature $T_e(0, t)$ is calculated from equation based on Spitzer's resistivity formula (see eg. [2],[4]):

$$T_e(0, t) = \left(\frac{R_0}{a^2} \frac{8Z_{eff.}}{1544} \frac{1}{R_p(t)} \right)^{2/3}, [eV; m, \Omega]$$

For particular case of the GOLEM tokamak it says:

$$T_e(0, t) = 0.9 \cdot \left(\frac{I_p(t)}{U_I(t)} \right)^{2/3}, [eV; A, V]$$

Towards Electron energy confinement time τ_E

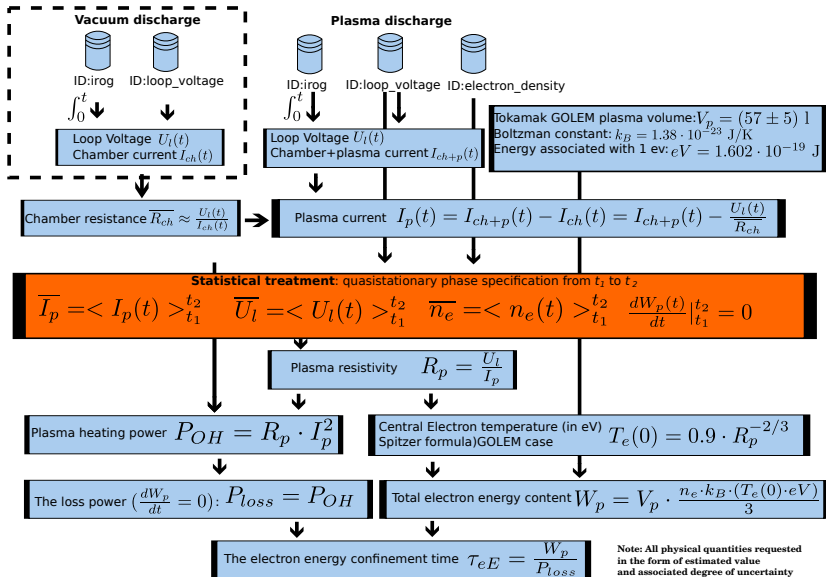

The GOLEM tokamak - standard diagnostics

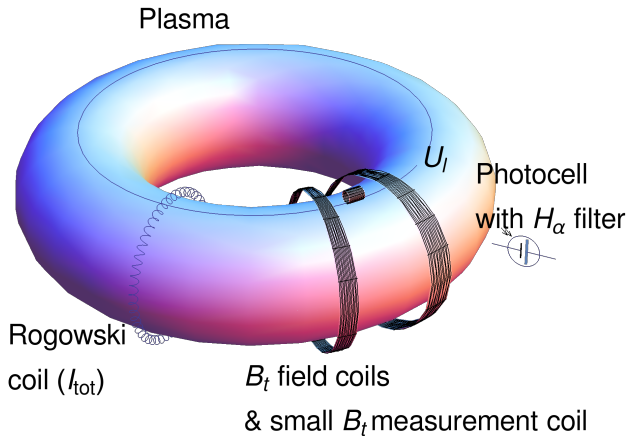

Hands on the GOLEM tokamak - equipment



The GOLEM tokamak interferometry HW

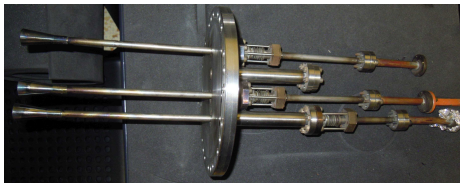

Vacuum x Plasma discharge @ Oscilloscope

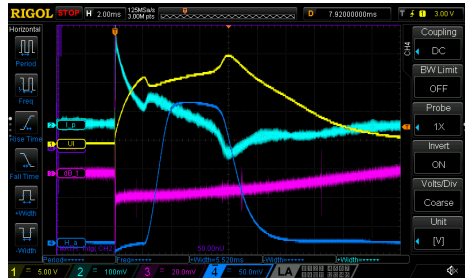
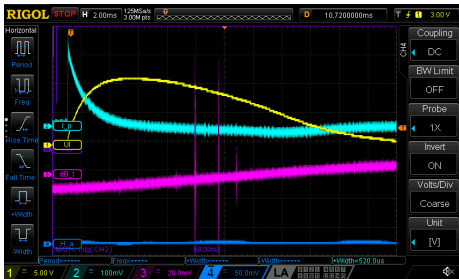

Vacuum x Plasma shot

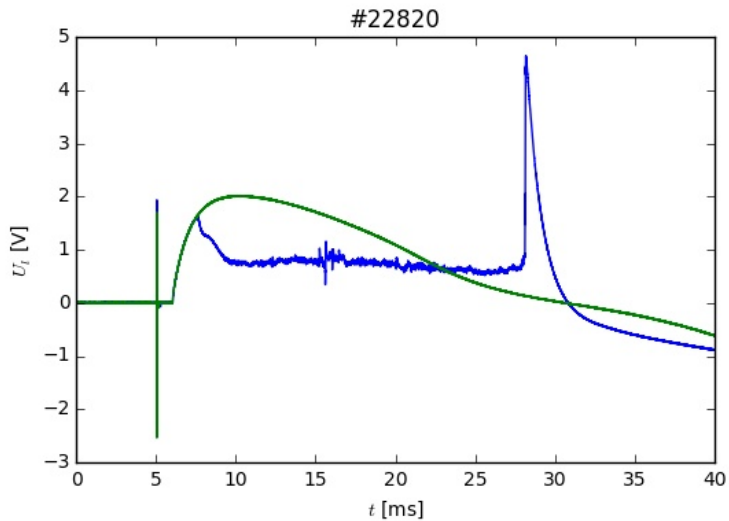

Table of Contents

1 Introduction

2 The Tokamak (GOLEM)

3 The Tokamak GOLEM (remote) operation

4 Conclusion

5 Appendix

- The Electron energy confinement time calculation (rough estimation)
- A
- Few moments from the tokamak GOLEM history

note on magnetic measurements

Schematic of electromagnetic diagnostics

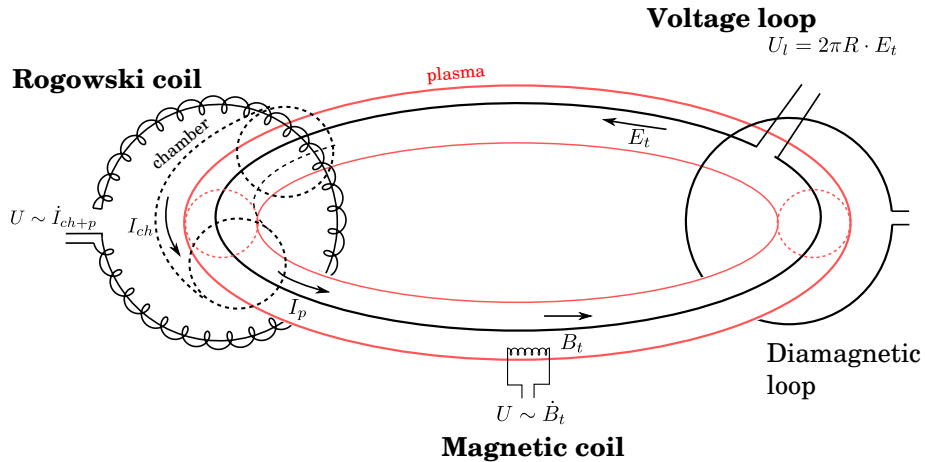

Rogowski coil for the (chamber & plasma) current I_{ch+p} measurements

Rogowski coil

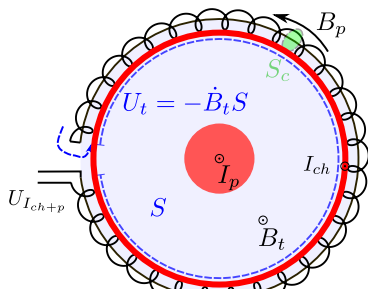
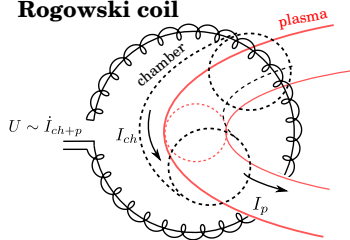

- Ampere's Law: $\nabla \times \mathbf{B} = \mu_0 \mathbf{j}$
(neglecting $\dot{\mathbf{D}}$)
- current through (const) surface S :
 $\int \mathbf{j} \cdot d\mathbf{S} = I_{ch+p}$
- (const) poloidal field along surface border l : $\int \nabla \times \mathbf{B} \cdot d\mathbf{S} = \oint B_p dl = I B_p$
- voltage induced: $U_{I_{ch+p}} + U_t - U_t = -N \dot{B}_p S_c = -\mu_0 \frac{N S_c}{l} \dot{I}_{ch+p}$
- The wire of the coil is back-wound to omit a strong toroidal magnetic field B_t signal.

Magnetic measurements generally I

- Raw signals (analog $U_r(t)$ or, respectively, it's discretized digital U_i counterpart form) must be specially maintained:
 - corrected for the DC bias U_{offset} of the measurement circuit,
 - integrated (pure diagnostics signal voltage $U_d(t)$ is induced by the time derivative of the appropriate magnetic flux),
 - multiplied by calibration factors C_d (C_{Bt} , C_{RC}).
- We can express the basic relationship $U_r(t) = U_d(t) + U_{offset}$
- The measured signal $U_d(t)$ is proportional to the time derivative of the original physical quantity $D(t)$ signal (it is a magnetic measurement):

$$U_d(t) \propto \frac{dD(t)}{dt}, \text{ or } U_d(t) = C_d \frac{dD(t)}{dt}$$

Where the linearity coefficient C_d is called a calibration factor.

Magnetic measurements generally II

- To determine the desired physical quantity $D(t)$, we just have to perform an integration over time:

$$D(t) = \frac{1}{C_d} \int_0^t U_d(t') dt' = \frac{1}{C_d} \int_0^t (U_r(t) - U_{offset}) dt'$$

- In reality, the measurement is not continuous. The system performs a series of measurements U_i separated by with time step $\Delta t = 1 \text{ us}$.
- In practice, we replace the integral by a sum:

$$D_i = \frac{1}{C_d} \sum_{j=0}^{t/\Delta t} (U_i(t_j) - U_{offset}) \Delta t$$

$$D_i = \frac{1}{C_d} \left(\sum_{j=0}^{t/\Delta t} U_i(t_j) \right) - U_{offset} t$$

- The offset U_{offset} can be specified from the beginning of the data series before switching on the real experiment.

Magnetic measurement demo - game with U_{offset}

Without U_{offset}

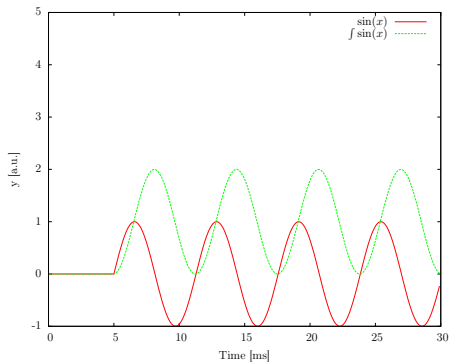

With U_{offset}

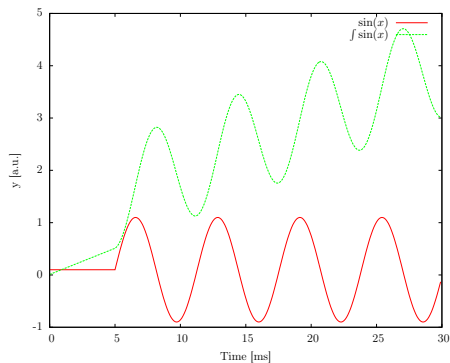

Table of Contents

1 Introduction

2 The Tokamak (GOLEM)

3 The Tokamak GOLEM (remote) operation

4 Conclusion

5 Appendix

- The Electron energy confinement time calculation (rough estimation)
- A
- Few moments from the tokamak GOLEM history

XX/YY: TM-1

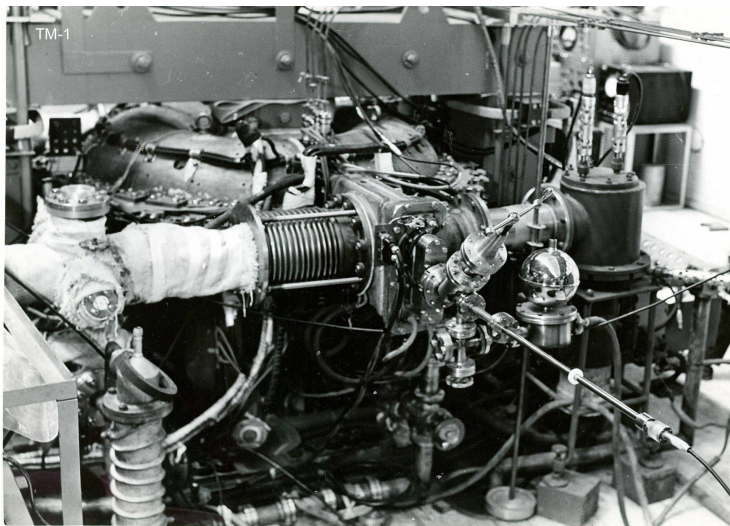

XX/YY: CASTOR

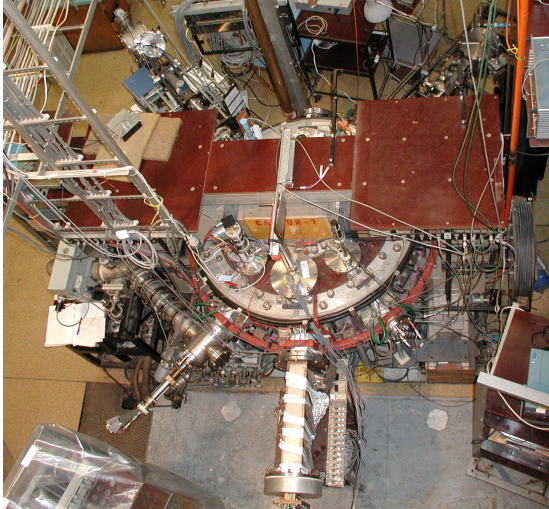

12/07: Last minutes at the IPP Prague



12/07: First minutes at the CTU Prague



07/09: First plasma in the tokamak GOLEM

Časové průběhy signálů zřetelně ukazují, že došlo k průrazu neutrálního plynu a k zformování plazmatu.

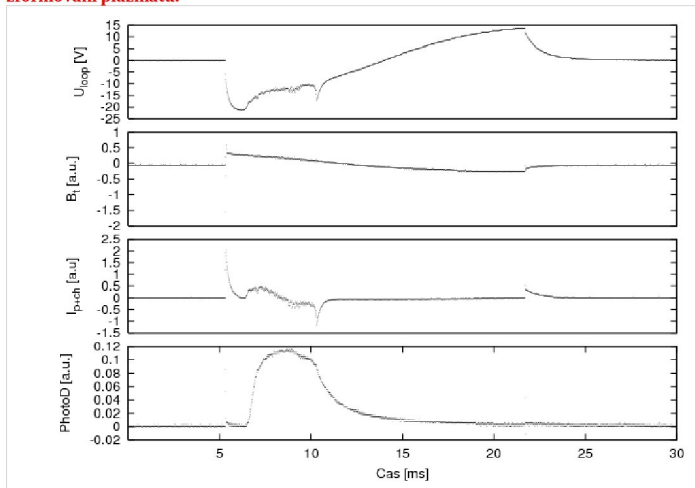

O tom svědčí:

1. Rychlý pokles napětí na závit v čase $t = 6-7$ ms a jeho malé fluktuace, které lze vidět až

09/09: Tokamak and tokamak

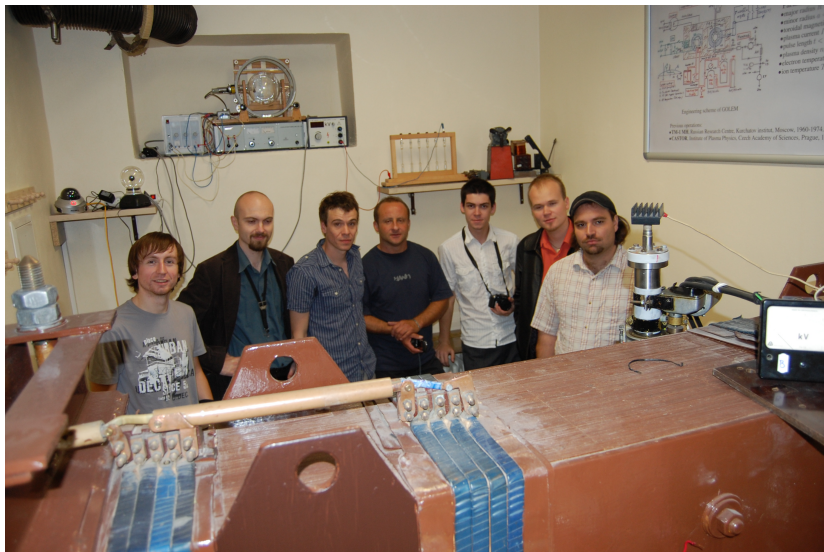

11/11: NP laureat at tokamak GOLEM

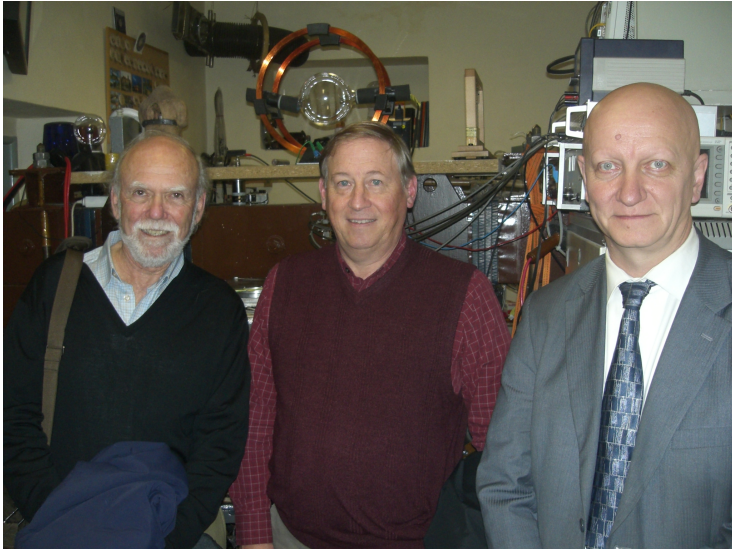

05/16: The youngest tokamak (GOLEM) operator, Adam (7 years).

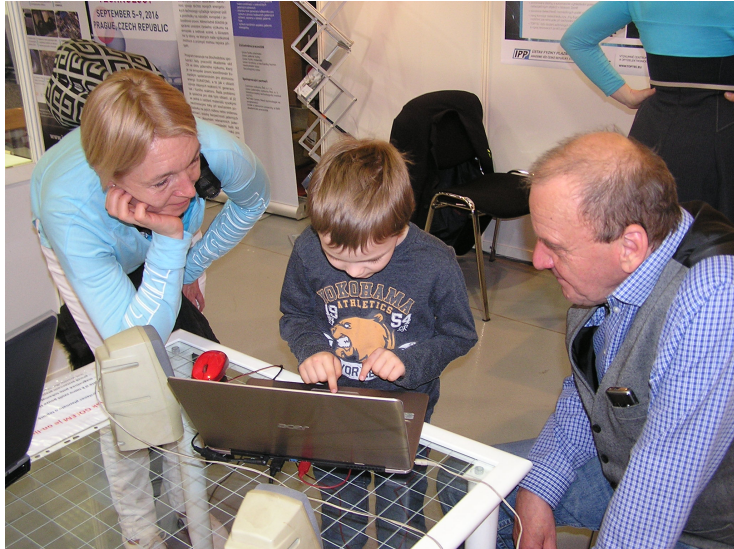

0916: ITER DG, Mr. Bernard Bigot (Shot #22185)

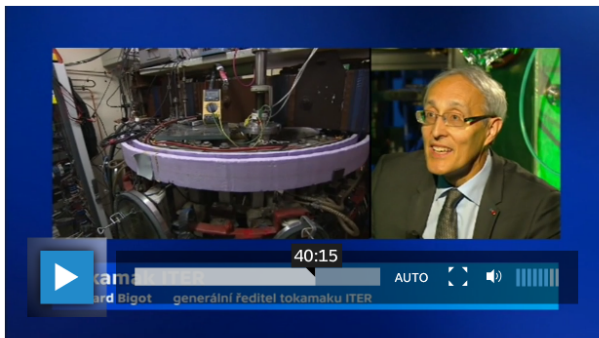

Quotation from Czech Television Hydepark

I am very pleased with the GOLEM ...

09/19 Paper model ABC

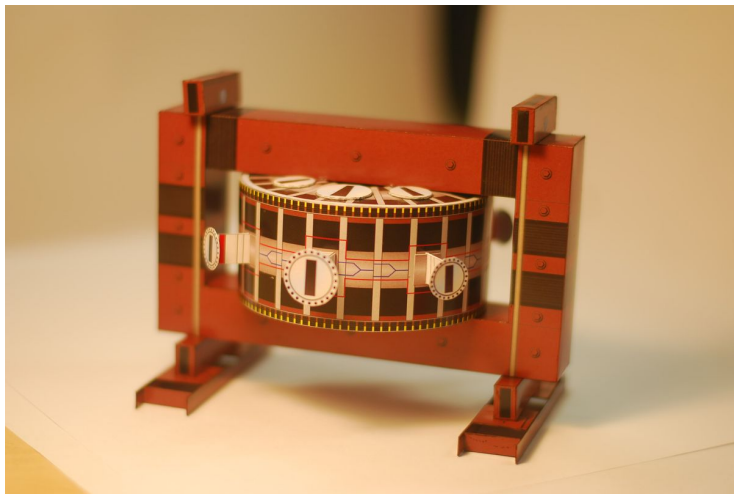

2010: Tokamak GOLEM



2011: The tokamak COMPASS with NBI



2016: ITER segment



2017: First Spitzer Stellarator



10/15: Trojan horse - #20000

GOLEM - Shot #20000 -



Diagnostics

- ✓ PlasmaPosition_TO
- ✗ Filers
- ✗ Spectrometer
- ✓ FastCamera
- ✓ HXR

Analysis

- ✓ HistoricalAnalysis
- ✓ ShotHomepage
- ✓ AdvancedAnalysis
- ✓ Spectrogramm_TO
- ✗ MultiCWT_TO
- ✓ MWPrevisualization
- ✗ Inverted_TO

DAS

- ✓ TeatroniCPO
- ✓ Pappouch_3
- ✓ Notstandard
- ✓ Pappouch_Za
- ✓ Pappouch_Sl

Vacuum log

Charging log

Other

- Data
- References
- About
- Wiki
- Utilities

Navigation

- Next
- Previous
- Current

Go to shot

20000

previous | next | current

Tokamak GOLEM - Shot Database - 20000

Date: 2015-10-22 - 16:09:25
Session: SessionPreparation
Comment: 20k

[Template source]
[WbLog]

Congratulation, you have reached nuclear fusion.

The following explosion destroyed half of Prague and radioactive fallout contaminated whole Europe.
Have a nice day



Basic parameters: (compare)

- Gas pressure $p_{D,20}$: 10,28->15,38 mPa (request: 5 mPa) ^{new}
- Working gas: H
- Preionization: Upper el. gun
- Chamber temperature: 20.00 C
- C_{B1} capacitors charged to: 1000 V, triggered 5:0.85 ^{new}
- C_{B2} capacitors charged to: 0 V, triggered 5:0.85 ^{new}
- C_{C2} capacitors charged to: 500 V, triggered 6:0.85 ^{new}
- C_{S1} capacitors charged to: 0 V, triggered 5:0.85 ^{new}
- Probability of breakdown: N/A ^{new}
- Time since session beginning: 0:19:25 h

Plasma parameters:

- Plasma life time 8.7 [ms] (from 7.5 to 16.2)
- Mean toroidal magnetic field Bt: 0.22 T ^{new}
- Mean plasma current: 1.42 kA ^{new}
- Mean Uloop: 12.41 V ^{new}
- Break down voltage: 10.5 V ^{new}
- Ohmic heating power: 17.59 kW
- Q edge: 6.9 ^{new}
- Electron temperature: 13.5 eV ^{new}
- Line electron density: N/A [$10^{17} \cdot m^{-2}$] ^{new}

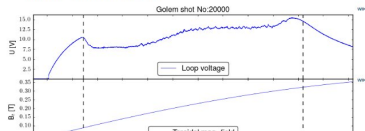

11/17: GOLEM tokamak "mapping"

Tokamak GOLEM



Základní (řádová) statistika k 30.11.2012

Počet dní od instalace: 1815.

Počet operačních dní: ≈ 438 .

Počet hodin: ≈ 1954

Počet shotů: 10417.

Počet shotů – $>$ plazma: ≈ 7600 .

Průměrná délka výboje: ≈ 7 ms.

Celková délka trvání plazmatu: < 60 s.